

# JVC

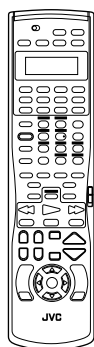

## AUDIO/VIDEO CONTROL RECEIVER

# RX-8040B

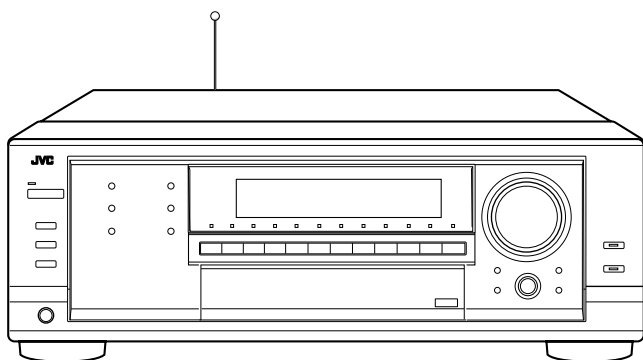

AV COMPU LINK

## INSTRUCTIONS

**For Customer Use:**

Enter below the Model No. and Serial No. which are located either on the rear, bottom or side of the cabinet. Retain this information for future reference.

Model No. \_\_\_\_\_

Serial No. \_\_\_\_\_

LVT1198-001A

[J]

# Warnings, Cautions and Others/ Mises en garde, précautions et indications diverses



The lightning flash with arrowhead symbol, within an equilateral triangle is intended to alert the user to the presence of uninsulated "dangerous voltage" within the product's enclosure that may be of sufficient magnitude to constitute a risk of electric shock to persons.



The exclamation point within an equilateral triangle is intended to alert the user to the presence of important operating and maintenance (servicing) instructions in the literature accompanying the appliance.

**WARNING: TO REDUCE THE RISK OF FIRE OR ELECTRIC SHOCK, DO NOT EXPOSE THIS APPLIANCE TO RAIN OR MOISTURE.**

## For U.S.A.

This equipment has been tested and found to comply with the limits for a Class B digital device, pursuant to part 15 of the FCC Rules. These limits are designed to provide reasonable protection against harmful interference in a residential installation.

This equipment generates, uses and can radiate radio frequency energy and, if not installed and used in accordance with the instructions, may cause harmful interference to radio communications. However, there is no guarantee that interference will not occur in a particular installation. If this equipment does cause harmful interference to radio or television reception, which can be determined by turning the equipment off and on, the user is encouraged to try to correct the interference by one or more of the following measures:

Reorient or relocate the receiving antenna.  
Increase the separation between the equipment and receiver.  
Connect the equipment into an outlet on a circuit different from that to which the receiver is connected.

## For the remote control:

This device complies with Part 15 of the FCC Rules. Operation is subject to the following two conditions: (1) This device may not cause harmful interference, and (2) this device must accept any interference received, including interference that may cause undesired operation.

Changes or modifications not expressly approved by the manufacturer for compliance could void the user's authority to operate the equipment.

## Note to CATV system installer:

This reminder is provided to call the CATV system installer's attention to Section 820-40 of the NEC which provides guidelines for proper grounding and, in particular, specifies that the cable ground shall be connected to the grounding system of the building, as close to the point of cable entry as practical.

## CAUTION

To reduce the risk of electrical shocks, fire, etc.:

1. Do not remove screws, covers or cabinet.
2. Do not expose this appliance to rain or moisture.

## ATTENTION

Afin d'éviter tout risque d'électrocution, d'incendie, etc.:

1. Ne pas enlever les vis ni les panneaux et ne pas ouvrir le coffret de l'appareil.
2. Ne pas exposer l'appareil à la pluie ni à l'humidité.

## Caution— $\phi$ /I STANDBY/ON button!

Disconnect the mains plug to shut the power off completely. The  $\phi$ /I STANDBY/ON button in any position does not disconnect the mains line. The power can be remote controlled.

## Attention—Commutateur $\phi$ /I STANDBY/ON!

Déconnecter la fiche de secteur pour couper complètement le courant. Le commutateur  $\phi$ /I STANDBY/ON ne coupe jamais complètement la ligne de secteur, quelle que soit sa position. Le courant peut être télécommandé.

## For Canada/pour Le Canada

### For the main unit / Pour l'appareil principal

**CAUTION:** TO PREVENT ELECTRIC SHOCK, MATCH WIDE BLADE OF PLUG TO WIDE SLOT, FULLY INSERT

**ATTENTION:** POUR EVITER LES CHOCS ELECTRIQUES, INTRODUIRE LA LAME LA PLUS LARGE DE LA FICHE DANS LA BORNE CORRESPONDANTE DE LA PRISE ET POUSSER JUSQU'AU FOND

THIS DIGITAL APPARATUS DOES NOT EXCEED THE CLASS B LIMITS FOR RADIO NOISE EMISSIONS FROM DIGITAL APPARATUS AS SET OUT IN THE INTERFERENCE-CAUSING EQUIPMENT STANDARD ENTITLED "DIGITAL APPARATUS," ICES-003 OF THE DEPARTMENT OF COMMUNICATIONS. CET APPAREIL NUMERIQUE RESPECTE LES LIMITES DE BRUITS RADIOELECTRIQUES APPLICABLES AUX APPAREILS NUMERIQUES DE CLASSE B PRESCRITES DANS LA NORME SUR LE MATERIEL BROUILLEUR; "APPAREILS NUMERIQUES", NMB-003 EDICTEE PAR LE MINISTRE DES COMMUNICATIONS.

### For the remote control / Pour la télécommande

This device complies with RSS-210 of Industry Canada Rules. Operation is subject to the following two conditions: (1) This device may not cause interference, and (2) this device must accept any interference, including interference that may cause undesired operation of the device.

Cet appareil est conforme au règlement CNR-210 de l'industrie du Canada. L'utilisation de ce dispositif est autorisée seulement aux conditions suivantes: (1) il ne doit pas produire de brouillage et (2) l'utilisateur du dispositif doit être prêt à accepter tout brouillage radioélectrique reçu, même si ce brouillage est susceptible de compromettre le fonctionnement du dispositif.

# Introduction

*We would like to thank you for purchasing one of our JVC products.  
Before operating this unit, read this manual carefully and thoroughly to obtain the best possible performance  
from your unit, and retain this manual for future reference.*

## Features

### CC (Compression Compensative) Converter

CC Converter eliminates jitter and ripples, achieving a drastic reduction in digital distortion by processing the digital music data in 24 bit-quantization and by expanding the sampling frequency to 128 kHz (for fs 32 kHz signals)/176.4 kHz (for fs 44.1 kHz signals)/192 kHz (for fs 48 kHz signals). By using the CC Converter, you can obtain a natural sound field from any source. (See page 23 for details.)

### K2 Technology

K2 Technology has been designed to enable natural audio reproduction, achieving a drastic reduction in digital distortion and creating original sound ambience with high precision.

### Compatible with various audio formats including Dolby Pro Logic IIx

This receiver allows you to enjoy audio formats such as Dolby Digital EX, Dolby Pro Logic IIx, DTS-ES, DTS Neo:6, and DTS 96/24.

- This receiver is also compatible with Dual Mono signals recorded in Dolby Digital and DTS discs.

### DAP (Digital Acoustic Processor)

Sound field simulation technology allows precise ambience recreation of existing theaters and halls. Thanks to the high-performance DSP (Digital Signal Processor) and high-capacity memory, you can enjoy multi-channel surround sound by playing 2-channel or multi-channel software according to the speaker setting.

### Multi-channel headphone virtual surround sound—3D Headphone mode

The built-in headphone virtual surround system is compatible with multi-channel software like Dolby Digital, DTS, etc. Thanks to the signal processing algorithms used by the high-performance DSP, you can enjoy a natural surround sound through the headphones.

### Multi-room operations

You can connect two pairs of front speakers to this receiver, and use them to listen to different sources in different rooms (Zone 1 and Zone 2) at the same time.

### COMPU LINK/AV COMPU LINK remote control systems

These functions allow you to operate other JVC's audio/video components from this receiver.

## Precautions

### General

- Be sure your hands are dry.
- Turn the power off to all components.
- Read the manuals supplied with the components you are going to connect.

### Power sources

- When unplugging the receiver from the wall outlet, always pull the plug, not the AC power cord.
- Do not handle the AC power cord with wet hands.
- If you are not going to operate the receiver for an extended period of time, unplug the AC power cord from the wall outlet.

### Multi-room operations

- Do not use the remote control outdoors or install the speakers outdoors.
- When operating the receiver from a place where you cannot see the receiver (for example, when controlling the receiver installed in the living room from the kitchen), pay attention to the following not to surprise other people:
  - Be careful not to turn up the volume too high when controlling the receiver without listening to the playback sound.
  - Be careful not to surprise other people with a sudden sound coming out of the receiver when turning it on. (A sudden stop of the sound may also surprise other people.)
- If the receiver operates by itself or malfunctions, the following causes should be considered:
  - Interference to RF communication between the receiver and the remote control from outside.
  - The remote control is operated unintentionally. For example, a book is placed on the remote control, possibly, depressing some of its buttons.
- If your neighbour uses the same or similar RF remote control system, the receiver may happen to receive the RF signals sent from such an RF remote control system, which could cause your receiver to be operated unintentionally. If this happens, stop using the RF rod antenna and the remote control, and consult your JVC dealer or the nearest JVC Service Center.

### Location

- Install the receiver in a location that is level and protected from moisture and dust.
- The temperature around the receiver must be between  $-5^{\circ}\text{C}$  and  $35^{\circ}\text{C}$  ( $23^{\circ}\text{F}$  and  $95^{\circ}\text{F}$ ).

### Ventilation

High power amplifiers built in this receiver will generate heat inside the cabinet. For safety, observe the following carefully.

- Make sure there is good ventilation around the receiver. Poor ventilation could overheat and damage the receiver.
- Do not block the ventilation openings or holes. (If the ventilation openings or holes are blocked by a newspaper or cloth, etc., the heat may not be able to get out.)

### Others

- Do not insert any metal object into the receiver.
- Should any metallic object or liquid fall onto the unit, unplug the unit and consult your dealer before operating any further.
- Do not expose this apparatus to rain, moisture, dripping or splashing and that no objects filled with liquids, such as vases shall be placed on the apparatus.
- Do not disassemble the receiver or remove screws, covers, or cabinet.

If anything goes wrong, unplug the AC power cord and consult your JVC dealer.

# Table of Contents

<b>Parts Identification</b> .....	<b>3</b>	<b>Basic Settings</b> .....	<b>32</b>
<b>Getting Started</b> .....	<b>7</b>	Quick Speaker Setup .....	32
Checking the Supplied Accessories .....	7	Basic Setting Items .....	33
Connecting the FM and AM Antennas .....	7	Basic Procedure .....	34
Connecting the Speakers and Subwoofer .....	8	Setting the speakers .....	34
Connecting Audio/Video Components .....	10	Setting the speaker distance .....	35
■ Analog connections .....	10	Setting the bass sounds .....	35
■ Digital connections .....	14	Selecting the main or sub-channel .....	36
Connecting the RF Rod Antenna and IR Signal Transmitter ...	14	Setting the digital input terminals .....	37
Connecting the Power Cord .....	15	Setting the component video input .....	38
Putting Batteries in the Remote Control .....	15	Setting the Zone 2/Speakers 2 .....	38
		Memorizing the volume level for each source .....	38
<b>Multi-room Operations</b> .....	<b>16</b>	<b>Adjusting Sound</b> .....	<b>39</b>
Required Connections for Zone 2 .....	16	Basic Adjustment Items .....	39
Basic Operating Procedure for Zone 1 .....	17	Basic Procedure .....	40
Basic Operating Procedure for Zone 2 .....	18	Adjusting the equalization patterns .....	40
<b>Zone 1 (Main Room) Operations</b> .....	<b>19</b>	Adjusting the speaker output levels .....	40
Turning the Power On and Off (Standby) .....	19	Adjusting the sound parameters	
Canceling the Zone 1 Operations .....	19	for the Surround and DSP modes .....	41
Selecting the Zone 1 Source to Play .....	20	<b>Using the Surround Modes</b> .....	<b>42</b>
Adjusting the Zone 1 Volume .....	21	Reproducing Theater Ambience .....	42
Activating the Zone 1 Front Speakers .....	21	Introducing the Surround Modes .....	42
Turning On and Off the Subwoofer Sound .....	22	Activating the Surround Modes .....	44
Selecting the Analog or Digital Input Mode .....	22	■ Activating the Surround modes .....	44
Setting the Dynamic Range .....	23	■ Activating the EX/ES/PLIIx setting .....	45
Attenuating the Input Signal .....	23	Surround Modes Applicable to the Various Software .....	46
Turning Analog Direct On and Off .....	23	<b>Using the DSP Modes</b> .....	<b>48</b>
Making Sounds Natural .....	23	Reproducing the Sound Field .....	48
Changing the Source Name .....	24	Introducing the DSP Modes .....	48
Reinforcing the Bass .....	24	Activating the DSP Modes .....	49
Muting the Zone 1 Sound .....	24	<b>Using the DVD MULTI Playback Mode</b> .....	<b>50</b>
Changing the Display Brightness .....	24	Activating the DVD MULTI Playback Mode .....	50
Using the Sleep Timer .....	25	<b>COMPU LINK Remote Control System</b> .....	<b>51</b>
<b>Zone 2 (Sub-room) Operations</b> .....	<b>26</b>	<b>AV COMPU LINK Remote Control System</b> ...	<b>53</b>
Turning the Power On and Off (Standby)		<b>Operating JVC's Audio/Video Components</b> ...	<b>56</b>
and Selecting the Zone 2 Operations .....	26	Operating Audio Components .....	56
Canceling the Zone 2 Operations .....	27	Operating Video Components .....	58
Selecting the Zone 2 Source to Play .....	28	<b>Operating Other Manufacturers'</b>	
Adjusting the Zone 2 Volume .....	28	<b>Equipment</b> .....	<b>59</b>
Activating the Zone 2 Front Speakers .....	29	<b>Troubleshooting</b> .....	<b>63</b>
Muting the Zone 2 Sound .....	29	<b>Specifications</b> .....	<b>65</b>
<b>Receiving Radio Broadcasts</b> .....	<b>30</b>		
Tuning in to Stations Manually .....	30		
Using Preset Tuning .....	31		
Selecting the FM Reception Mode .....	31		



This mark indicates that ONLY the remote control CAN be used for the operation explained.



This mark indicates that the remote control CANNOT be used for the operation explained. Use the buttons and controls on the front panel.



Indicates the functions YOU CAN ALSO USE when the receiver is ready for Zone 2 operations.

# Parts Identification

## Remote Control

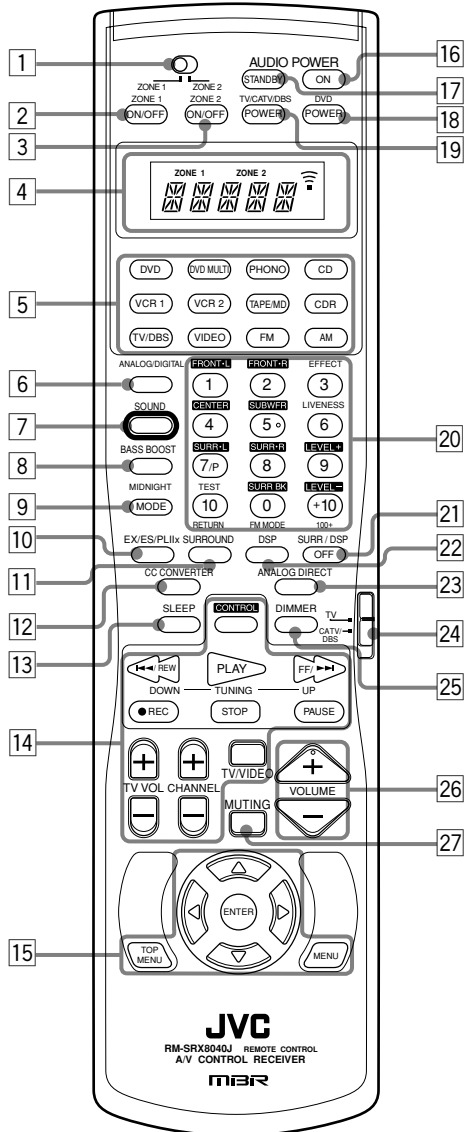

### Remote's display window

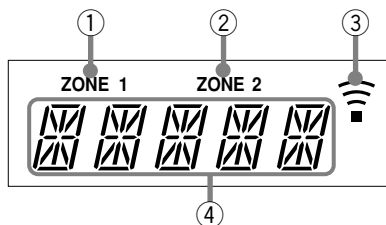

Refer to the pages in parentheses for details.

- 1 ZONE 1/ZONE 2 selector
- 2 ZONE 1 ON/OFF button (19, 52, 55, 56)
- 3 ZONE 2 ON/OFF button (27, 52, 55, 56)
- 4 Display window
- 5 Source selection buttons (17, 18, 20 – 22, 28, 30, 31, 50, 56 – 61)  
DVD, DVD MULTI, PHONO, CD, VCR 1, VCR 2, TAPE/MD, CDR, TV/DBS, VIDEO, FM, AM
- 6 ANALOG/DIGITAL button (22, 56)
- 7 SOUND button (41, 56)
- 8 BASS BOOST button (24, 56)
- 9 MIDNIGHT MODE button (23, 56)
- 10 EX/ES/PLIIx button (45, 56)
- 11 SURROUND button (44, 47, 56)
- 12 CC CONVERTER button (23, 56)
- 13 SLEEP button (25, 56)
- 14 CONTROL button (56 – 58)  
Operating buttons for audio/video components (57, 58, 60, 61)  
◀◀/REW, PLAY, FF/▶▶, ● REC, STOP, PAUSE  
Operating buttons for tuner (30, 56)  
TUNING UP/DOWN  
TV VOL (volume) +/- buttons (58, 59)  
CHANNEL +/- buttons (58 – 60)  
TV/VIDEO button (58, 59)
- 15 Operating buttons for DVD player (58, 61)  
TOP MENU, MENU, ENTER, ▷, ◁, △, ▽
- 16 AUDIO POWER ON button (17 – 19, 27, 52, 55, 56, 61)
- 17 AUDIO POWER STANDBY button (19, 27, 52, 55, 56)
- 18 DVD POWER button (53, 58, 60, 61)
- 19 TV/CATV/DBS POWER button (58 – 60)
- 20 10 keys for selecting preset channels (31, 56)  
10 keys for operating audio/video components (56 – 61)  
Sound and DSP effects adjustment buttons (41, 56)
- 21 SURR/DSP OFF button (44, 49, 56)
- 22 DSP button (48, 49, 56)
- 23 ANALOG DIRECT button (23, 56)
- 24 TV-CATV/DBS operation mode selector (58 – 60)
- 25 DIMMER button (24, 56)
- 26 VOLUME +/- buttons (17, 18, 21, 24, 28, 29, 56)
- 27 MUTING button (24, 29, 56)

### Remote's display window

- ① ZONE 1 indicator  
Lights up when you press a button on the remote control, with the ZONE 1/ZONE 2 selector set to "ZONE 1." This remote control can be used only for Zone 1 operations.
- ② ZONE 2 indicator  
Lights up when you press a button on the remote control, with the ZONE 1/ZONE 2 selector set to "ZONE 2." This remote control can be used only for Zone 2 operations.
- ③ Signal transmission indicator  
Lights up when transmitting the remote control signals.
- ④ Remote control main display  
Remote control operation mode such as "DVD," "CD," "SOUND," etc. appear.  
When the remote control operation mode is changed, the mode appears on this display for about 2 hours.

## Front Panel

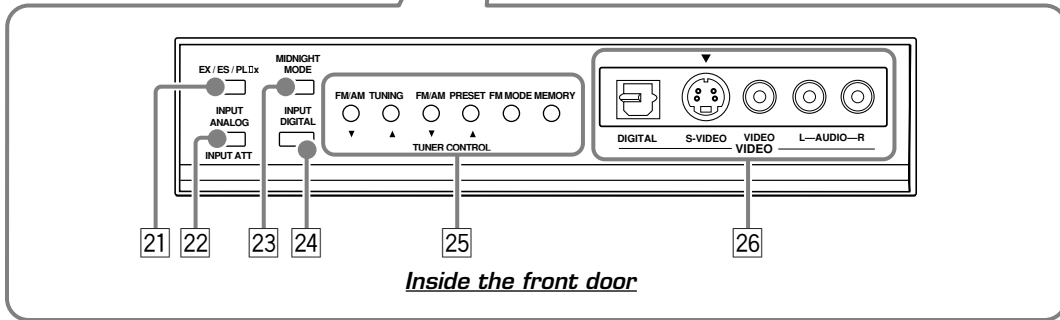
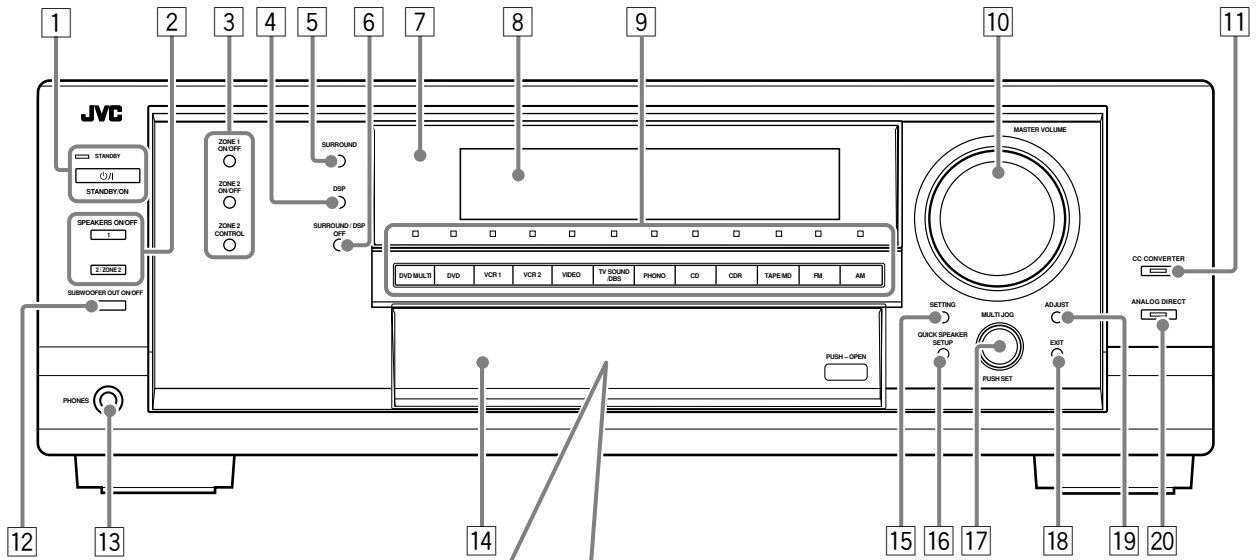

## How to open the front door

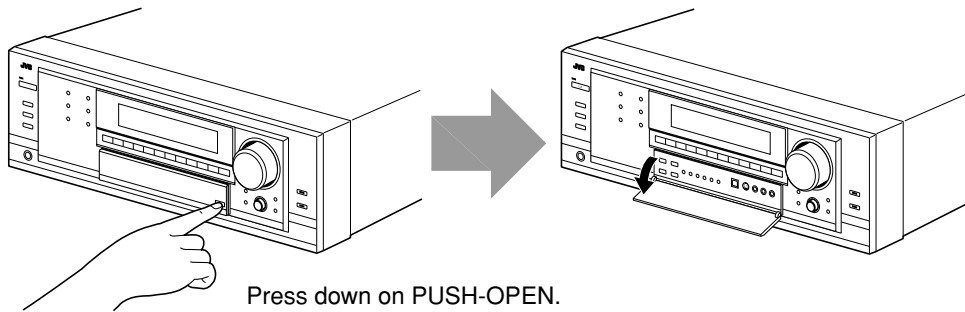

## Display

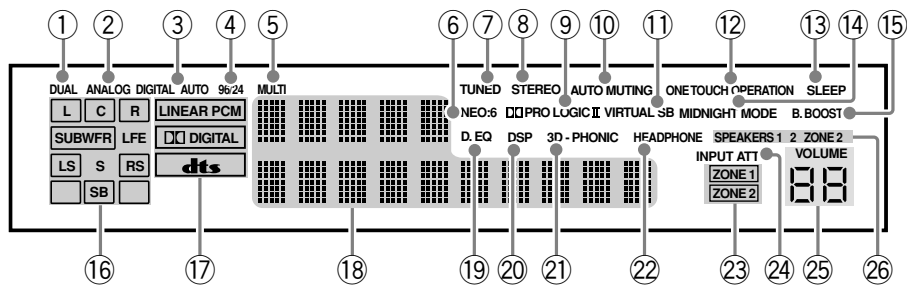



Refer to the pages in parentheses for details.

## Front Panel

- 1  STANDBY/ON button and STANDBY lamp (17 – 19, 26, 27, 52, 55)
- 2 SPEAKERS ON/OFF 1 button (17, 21)  
SPEAKERS ON/OFF 2/ZONE 2 button (17, 29)
- 3 ZONE 1 ON/OFF button (19, 25, 38, 52, 55)  
ZONE 2 ON/OFF button (18, 26, 27, 52, 55)  
ZONE 2 CONTROL button (18, 25 – 27, 38)
- 4 DSP button (48, 49)
- 5 SURROUND button (44, 47)
- 6 SURROUND/DSP OFF button (44, 49)
- 7 Remote sensor
- 8 Display
- 9 Source selection buttons and source indication lamps (17, 18, 20 – 22, 24, 28, 30, 31, 50)  
DVD MULTI, DVD, VCR 1, VCR 2, VIDEO,  
TV SOUND/DBS, PHONO, CD, CDR, TAPE/MD, FM, AM
- 10 MASTER VOLUME control (17, 18, 21, 24, 28, 29)
- 11 CC CONVERTER button and lamp (23)
- 12 SUBWOOFER OUT ON/OFF button (22)
- 13 PHONES jack (21)
- 14 Front door
- 15 SETTING button (34)
- 16 QUICK SPEAKER SETUP button (32)
- 17 MULTI JOG control (32, 34, 40)  
PUSH SET button (32, 34, 40)
- 18 EXIT button (34, 40)
- 19 ADJUST button (40)
- 20 ANALOG DIRECT button and lamp (23)
- 21 EX/ES/PLIIx button (45)
- 22 INPUT ANALOG button (22)  
INPUT ATT button (23)
- 23 MIDNIGHT MODE button (23)
- 24 INPUT DIGITAL button (22)
- 25 TUNER CONTROL buttons  
FM/AM TUNING ▲ / ▼ buttons (30)  
FM/AM PRESET ▲ / ▼ buttons (31)  
FM MODE button (31)  
MEMORY button (31)
- 26 VIDEO input jacks (11)  
DIGITAL optical terminal, S-VIDEO jack, VIDEO jack,  
AUDIO L/R jacks

## Display

- 1 DUAL indicator (43)
- 2 ANALOG indicator (22)
- 3 DIGITAL AUTO indicator (22)
- 4 96/24 indicator (43)
- 5 MULTI indicator (50)
- 6 NEO:6 indicator (43)
- 7 TUNED indicator (30)
- 8 STEREO indicator (30, 31)
- 9  PRO LOGIC indicator (42)  
 PRO LOGIC II indicator (42)
- 10 AUTO MUTING indicator (31)
- 11 VIRTUAL SB (surround back) indicator (43, 47)
- 12 ONE TOUCH OPERATION indicator (38)
- 13 SLEEP indicator (25)
- 14 MIDNIGHT MODE indicator (23)
- 15 B. BOOST (bass boost) indicator (24)
- 16 Speaker and signal indicators (20)
- 17 Digital signal format indicators (22, 42, 43)
- 18 Main display
- 19 D.EQ (digital equalization) indicator (40)
- 20 DSP indicator (21, 47, 48)
- 21 3D-PHONIC indicator (43, 47, 48)
- 22 HEADPHONE indicator (21, 47, 48)
- 23 ZONE 1/ZONE 2 indicators (17 – 19, 26, 27, 51, 52, 54, 55)
- 24 INPUT ATT (attenuator) indicator (23)
- 25 VOLUME level indicator (17 – 19, 21, 24, 26, 29)
- 26 SPEAKERS 1/2/ZONE 2 indicators (19, 21, 26, 29)

## Rear Panel

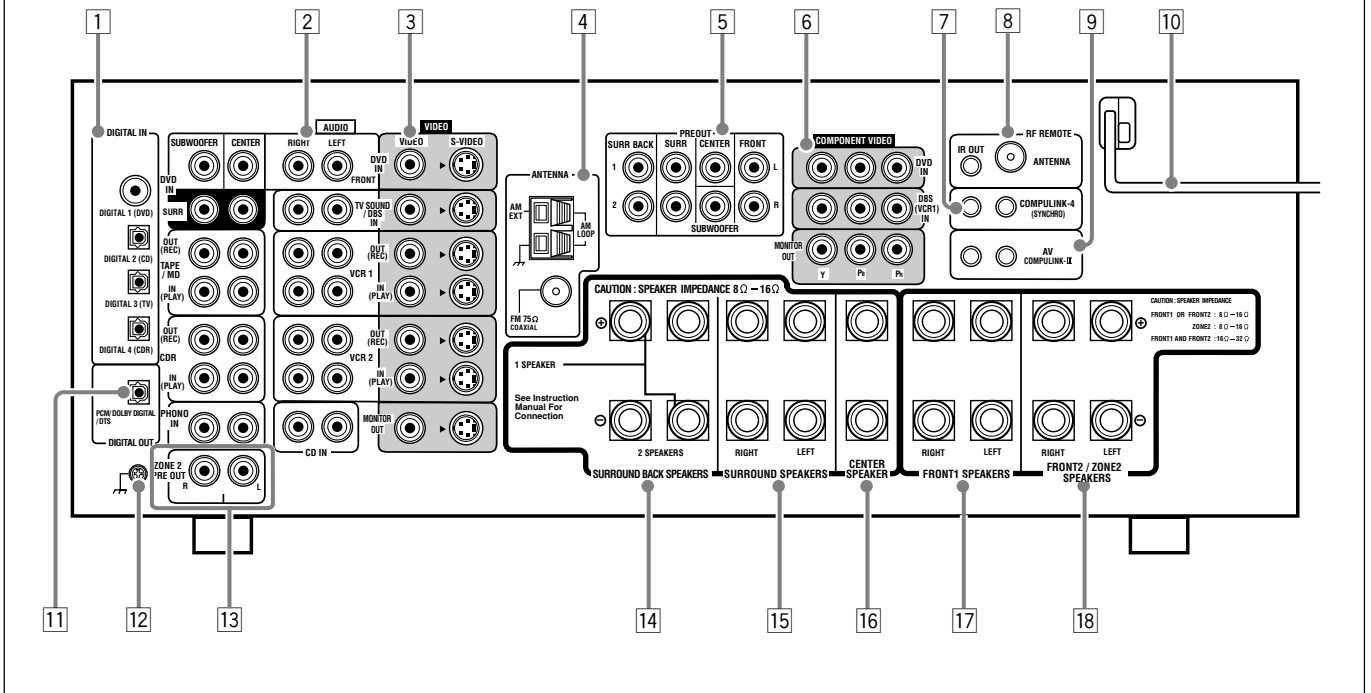

Refer to the pages in parentheses for details.

- |  |  |
|--|--|
| <p><b>1</b> DIGITAL IN terminals (14)<br/>                     Coaxial: DIGITAL 1 (DVD)<br/>                     Optical: DIGITAL 2 (CD), DIGITAL 3 (TV),<br/>                     DIGITAL 4 (CDR)</p> <p><b>2</b> AUDIO input/output jacks (10 – 13, 50)<br/>                     Input: DVD IN, TV SOUND/DBS IN, VCR 1 IN<br/>                     (PLAY), VCR 2 IN (PLAY), CD IN,<br/>                     TAPE/MD IN (PLAY), CDR IN (PLAY),<br/>                     PHONO IN<br/>                     Output: VCR 1 OUT (REC), VCR 2 OUT (REC),<br/>                     TAPE/MD OUT (REC), CDR OUT (REC)</p> <p><b>3</b> S-VIDEO and VIDEO (composite) input/output jacks<br/>                     (12, 13, 50)<br/>                     Input: DVD IN, TV SOUND/DBS IN,<br/>                     VCR 1 IN (PLAY), VCR 2 IN (PLAY)<br/>                     Output: VCR 1 OUT (REC), VCR 2 OUT (REC),<br/>                     MONITOR OUT</p> <p><b>4</b> ANTENNA terminals (7)</p> | <p><b>5</b> PREOUT jacks (8, 9)</p> <p><b>6</b> COMPONENT VIDEO input/output jacks (12, 13, 50)<br/>                     Input: DVD IN, DBS (VCR 1) IN<br/>                     Output: MONITOR OUT</p> <p><b>7</b> COMPULINK-4 (SYNCHRO) jacks (51)</p> <p><b>8</b> RF REMOTE ANTENNA terminal and IR OUT terminal<br/>                     (14, 15, 53)</p> <p><b>9</b> AV COMPULINK-III jacks (53)</p> <p><b>10</b> AC power cord (15)</p> <p><b>11</b> DIGITAL OUT (PCM/DOLBY DIGITAL/DTS) terminal<br/>                     (14)</p> <p><b>12</b> Earth (ground) terminal (10)</p> <p><b>13</b> ZONE 2 PREOUT jacks (16)</p> <p><b>14</b> SURROUND BACK SPEAKERS terminals (8)</p> <p><b>15</b> SURROUND SPEAKERS terminals (8)</p> <p><b>16</b> CENTER SPEAKER terminals (8)</p> <p><b>17</b> FRONT1 SPEAKERS terminals (8)</p> <p><b>18</b> FRONT2/ZONE2 SPEAKERS terminals (8, 16)</p> |
|--|--|



# Getting Started

This section explains how to connect audio/video components and speakers to the receiver, and how to connect the power supply.

**Do not connect the AC power cord until all other connections have been made.**

## Checking the Supplied Accessories

Check to be sure you have all of the following items, which are supplied for the receiver.  
The number in parentheses indicates the quantity of pieces supplied.

- Remote Control (1)
- Batteries (2)
- AM Loop Antenna (1)
- FM Antenna (1)
- RF Rod Antenna (1)
- IR Signal Transmitter (1)
- Double-sided Adhesive Tape (1)

If anything is missing, contact your dealer immediately.

## Connecting the FM and AM Antennas

### FM antenna connections

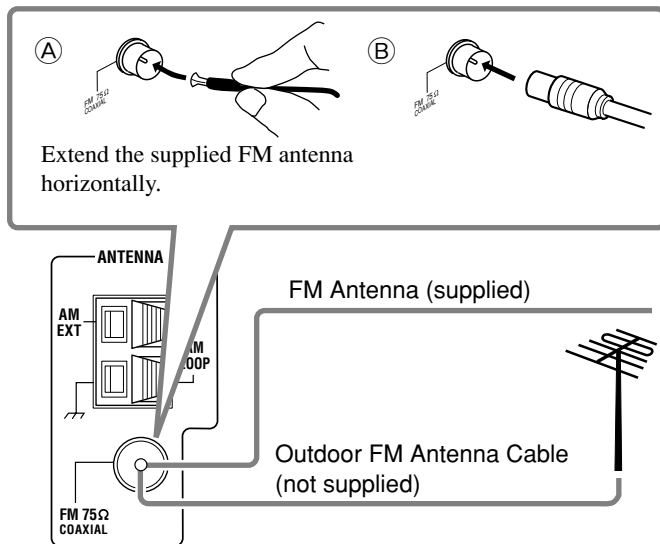

Connect the supplied FM antenna as temporary measure to the FM 75 Ω COAXIAL terminal—**A**

If reception is poor, connect the outdoor FM antenna (not supplied)—**B**

1. Disconnect the supplied FM antenna.
2. Connect a 75 Ω coaxial cable (with the standard type connector).

### AM antenna connections

Assemble the supplied AM loop antenna as follows:

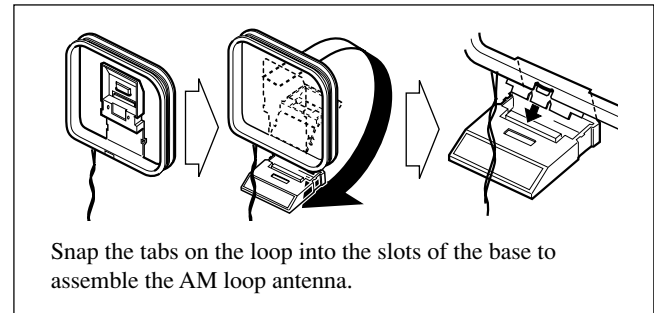

Turn the loop until you have the best reception.

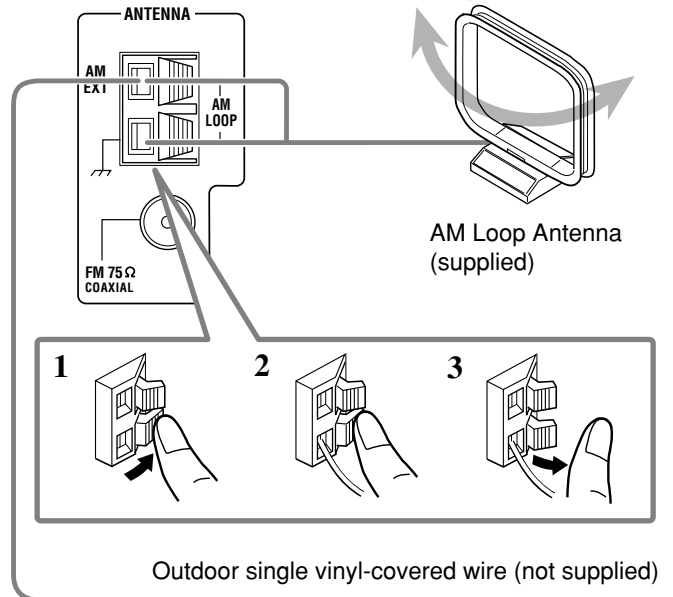

### Notes:

- If the AM loop antenna wire is covered with vinyl, remove the vinyl by twisting it as illustrated.
- Make sure the antenna conductors do not touch any other terminals, connecting cords and power cord. This could cause poor reception.
- If reception is poor, connect an outdoor single vinyl-covered wire (not supplied) to the AM EXT terminal. (Keep the AM loop antenna connected.)

## Connecting the Speakers and Subwoofer

You can connect the following speakers:

- Two pairs of front speakers.
- One pair of surround speakers.
- One pair of surround back speakers.
- One center speaker.
- One powered subwoofer.

### CAUTION:

- Use only the speakers of the SPEAKER IMPEDANCE indicated by the speaker terminals.
  - **When using only one pair of front speakers in Zone 1:**  
Connect the speakers with an impedance of 8 Ω to 16 Ω, and set the “FRONT SPEAKER2” (see page 38) to “FRONT SPK2:SPK2”.
  - **When using two pairs of front speakers separately in Zone 1 and Zone 2:**  
Connect the speakers with an impedance of 8 Ω to 16 Ω, and set the “FRONT SPEAKER2” (see page 38) to “FRONT SPK2:ZONE2”.
  - **When using two pairs of front speakers only in Zone 1:**  
Connect the speakers with an impedance of 16 Ω to 32 Ω, and set the “FRONT SPEAKER2” (see page 38) to “FRONT SPK2:SPK2”.
- Do not connect more than one speaker to each speaker terminal.

For each speaker (except for a subwoofer), connect the (+) and (–) terminals on the rear panel to the (+) and (–) terminals marked on the speakers.

## Speaker connections

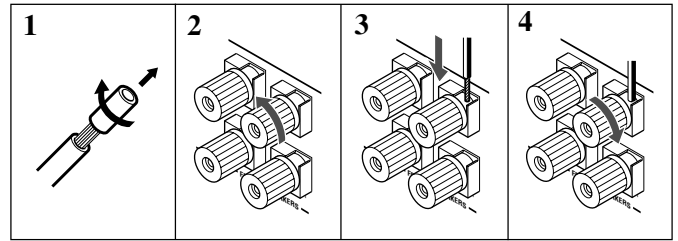

1. Cut, twist, and remove the insulation at the end of each speaker signal cable (not supplied).
2. Turn the knob counterclockwise.
3. Insert the speaker signal cable.
4. Turn the knob clockwise.

### IMPORTANT:

After connecting the speakers, set the speaker installation information properly. You can use Quick Speaker Setup for it (see page 32).

- To obtain the best possible Surround/DSP effect, see “Setting the Speakers” on page 34.

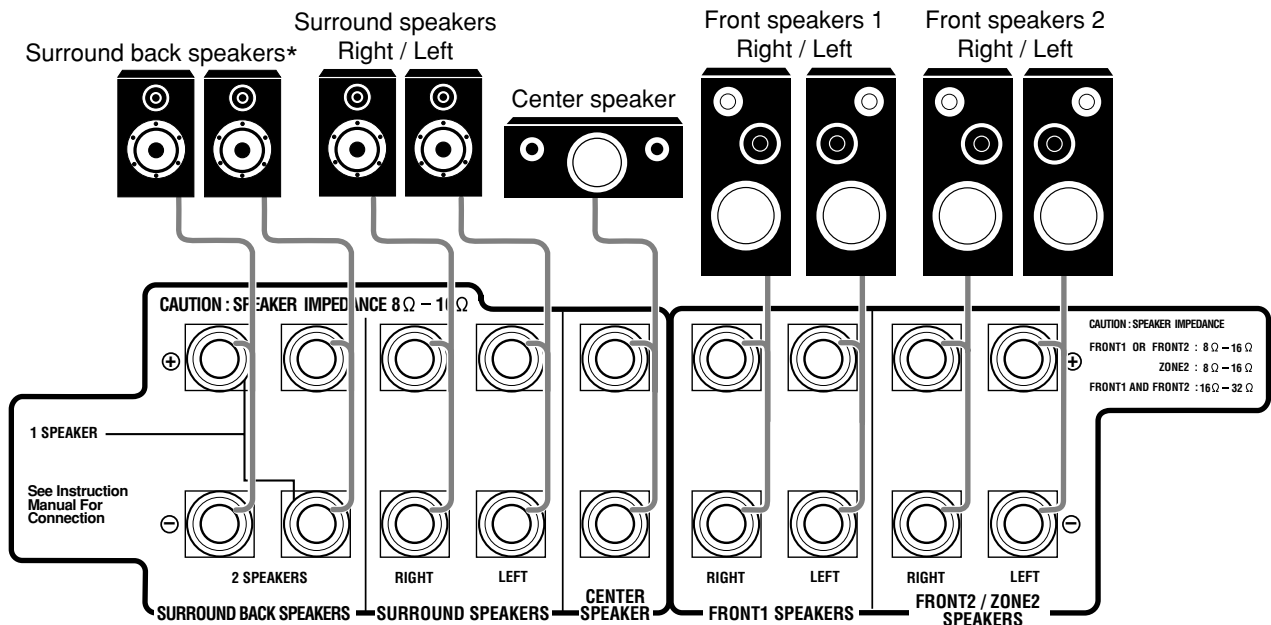

\* When using only one surround back speaker, connect the speaker as follows:

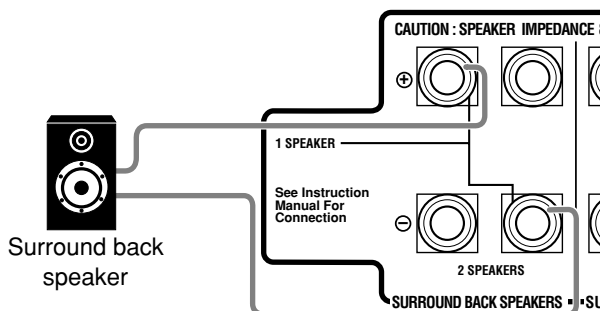

## Connecting the subwoofer

You can enhance the bass by connecting a subwoofer. Connect the input jack of a powered subwoofer to the rear panel, using a cable with RCA pin plugs (not supplied).

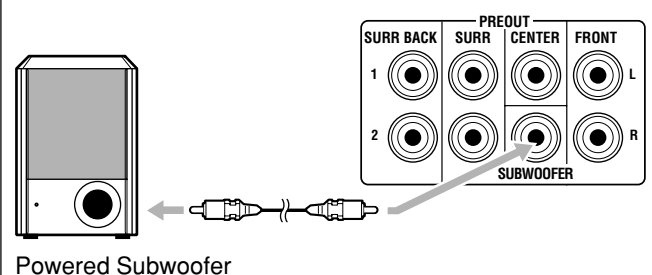

### Zone 1 speaker layout

Ideal speaker layout varies depending on the conditions of your listening room. The diagram below is a recommended typical example.

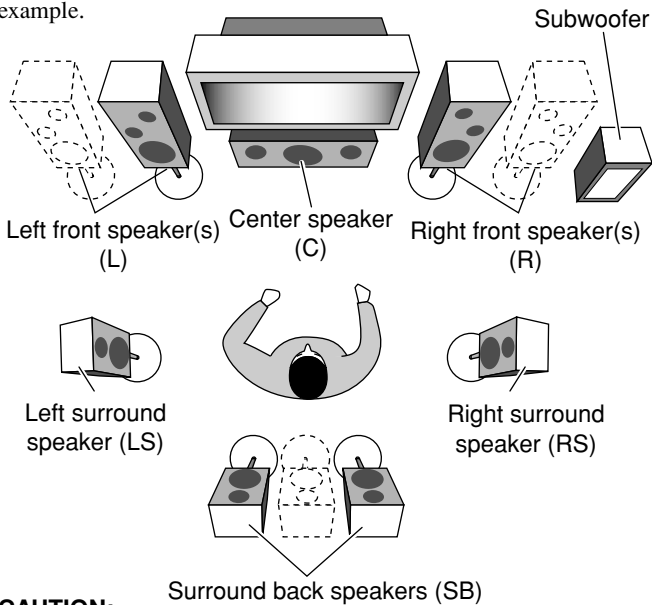

#### CAUTION:

Do not place the center speaker on the TV. If you do so, the center speaker may cause various troubles to the TV (for example, color unevenness). Moreover, it may hurt you by its falling from the TV.

### Placing speakers

#### Front speakers (L/R) and center speaker (C)

- Place these speakers at the same height from the floor, at or near ear level.
- Array across the front of the viewing area.

#### Surround speakers (LS/RS) and surround back speakers (SB)

- Place these speakers at a position which is 60 cm to 90 cm (2 ft to 3 ft) higher than the listener's ears.
- Point these speakers directly across the listening area, but not at the listener's ears.

#### Subwoofer

- You can place it wherever you like since bass sound is non-directional. Normally place it in front of you.

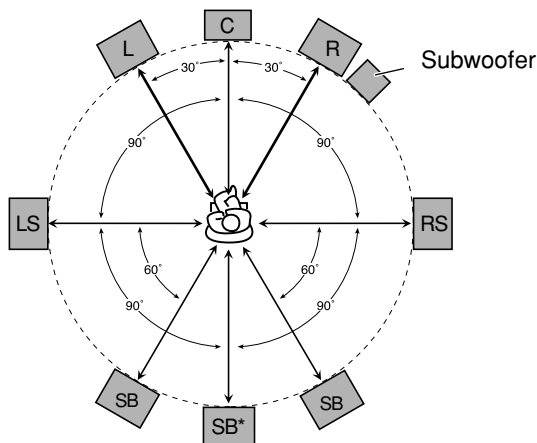

\* When only one speaker is connected for the surround back speaker.

#### Note:

Ideal speaker layout requires that all speakers be placed at the same distance from the listener. However, since in some places it may be difficult to fulfil this requirement, this receiver can adjust the delay time so that the sounds through all the speakers reach the listener with the same timing. (See page 35.)

### Enhance your audio system

You can use this receiver as the pre-amplifier (control amplifier) when you connect power amplifiers to the PREOUT jacks on the rear panel, using cables with RCA pin plugs (not supplied).

- Connect the white plug to the audio left jack, and the red plug to the audio right jack.

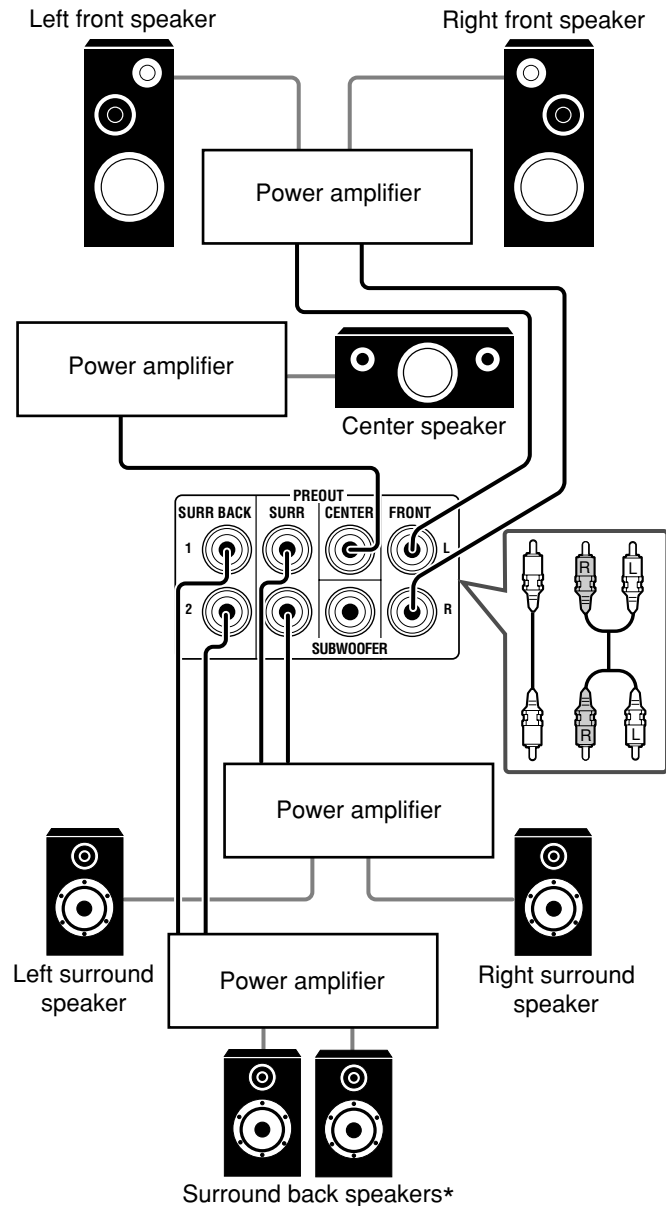
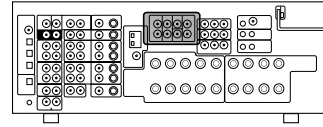

\* When using only one surround back speaker, connect the speaker as follows:

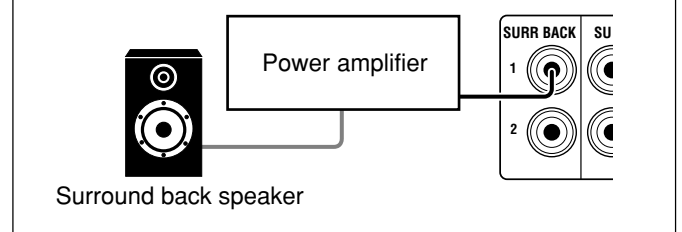

## Connecting Audio/Video Components

When connecting individual components, refer also to the manuals supplied with them.

### Analog connections

If your audio components have digital audio output terminal, connecting them using the digital cords explained in "Digital connections" (see page 14).

#### Audio component connections

Use the cables with RCA pin plugs (not supplied).

- Connect the white plug to the audio left jack, and the red plug to the audio right jack.

#### If your audio components have a COMPULINK jack

See also page 51 for detailed information about the connection and the COMPULINK remote control system.

#### CAUTION:

If you connect a sound-enhancing device such as a graphic equalizer between the source components and this receiver, the sound output through this receiver may be distorted.

### Turntable

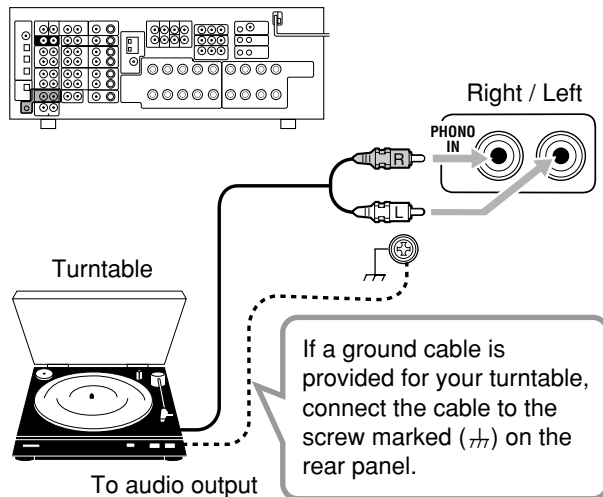

#### Note:

This connection is for the turntable with an MM (moving-magnet) type cartridge.

Any turntables incorporating a small-output cartridge such as an MC (moving-coil) type must be connected to this receiver through a commercial head amplifier or step-up transformer. Direct connection may result in insufficient volume.

### CD player

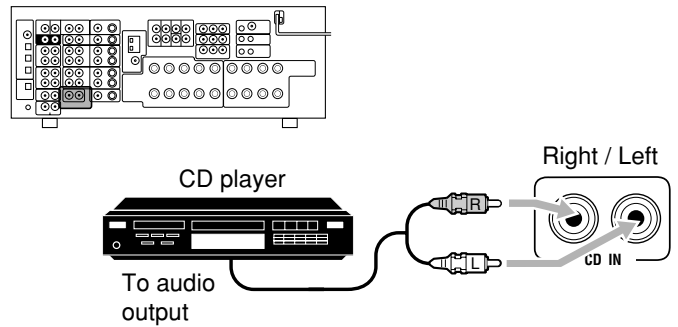

### CD recorder

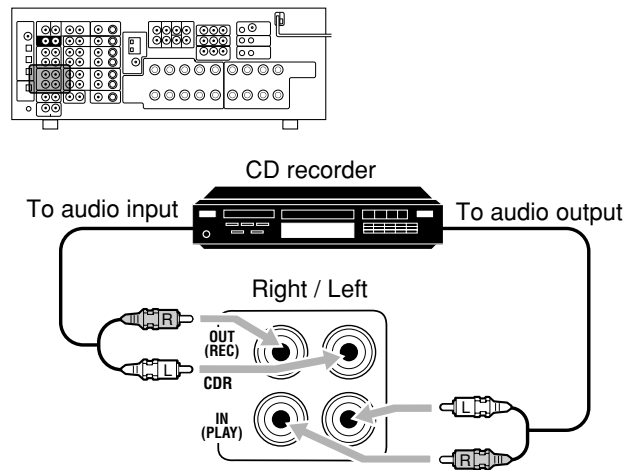

### Cassette deck

You can connect either a cassette deck or an MD recorder to the TAPE/MD jacks. When connecting an MD recorder, see below.

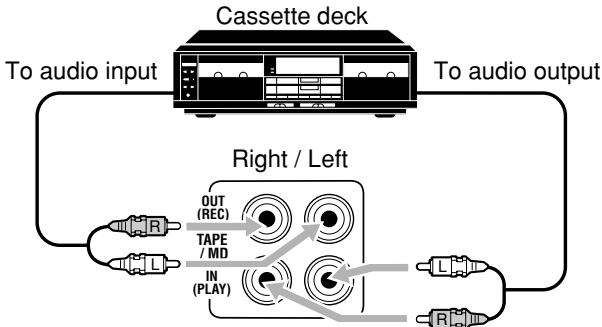
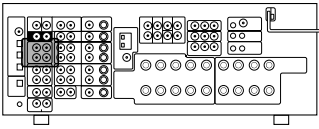

### MD recorder

You can connect either an MD recorder or a cassette deck to the TAPE/MD jacks. When connecting a cassette deck, see above.

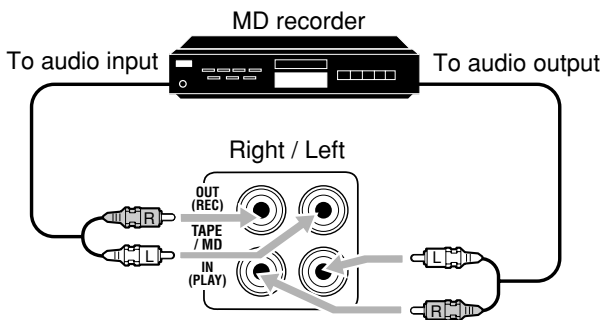
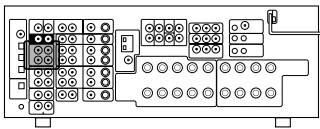

### Note:

When connecting an MD recorder to the TAPE/MD jacks, change the source name to "MD," which will appear on the display when it is selected as the source. See page 24 for details.

### Video component connections

Use the cables with RCA pin plugs (not supplied).

Connect the white plug to the audio left jack, the red plug to the audio right jack, and the yellow plug to the video jack.

- If your video components have S-video (Y/C-separation) and/or component video (Y, Pb, Pr) terminals, connect them using an S-video cable (not supplied) or component video cable (not supplied). By using these jacks, you can get better picture quality in the order:

Component video > S-video > Composite video

- If your video components have digital audio output terminal, connect them using the digital cords explained in "Digital connections" (see page 14).

### If your video components have an AV COMPULINK jack

See also page 53 for detailed information about the connection and the AV COMPULINK remote control system.

### IMPORTANT:

This receiver is equipped with the following video jacks—composite video, S-video and component video jacks. You can use any of the three to connect a video component.

However, **the video signals from one type of these input jacks are transmitted only through the video output jacks of the same type.**

Therefore, if a recording video component and a playing video component are connected to the receiver through the video jacks of different type, you cannot record the picture. In addition, if the TV and a playing video component are connected to the receiver through the video jacks of different type, you cannot view the playback picture on the TV.

### Video camera

The VIDEO input jacks on the front panel (inside the front door) are convenient when connecting and disconnecting the component frequently.

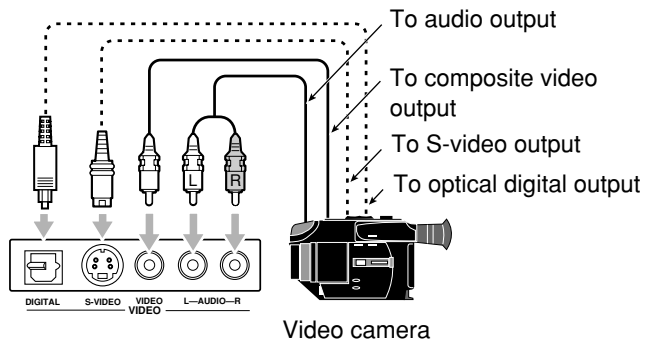
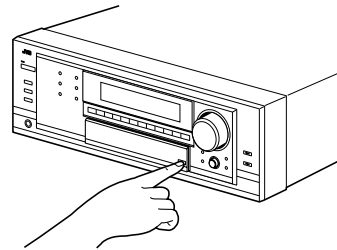

### Note:

When using the digital input terminal, select the digital input mode correctly. For details, see "Selecting the Analog or Digital Input Mode" on page 22.

## VCR(s)

You can connect two VCRs—one to the VCR 1 jacks and the other to the VCR 2 jacks.

- If your VCR has an AV COMPU LINK jack, connect it to the VCR 1 jacks so that you can use the AV COMPU LINK remote control system.

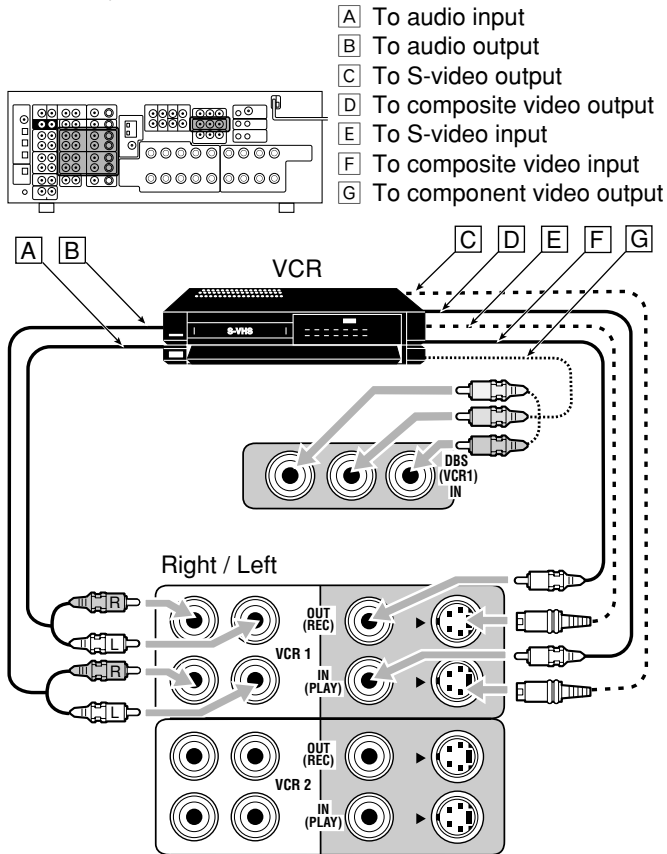

### Note:

When connecting a VCR to component video input jacks, make the component video input setting (VIDEO IN VCR1) correctly. See page 38 for details.

## TV and/or DBS tuner

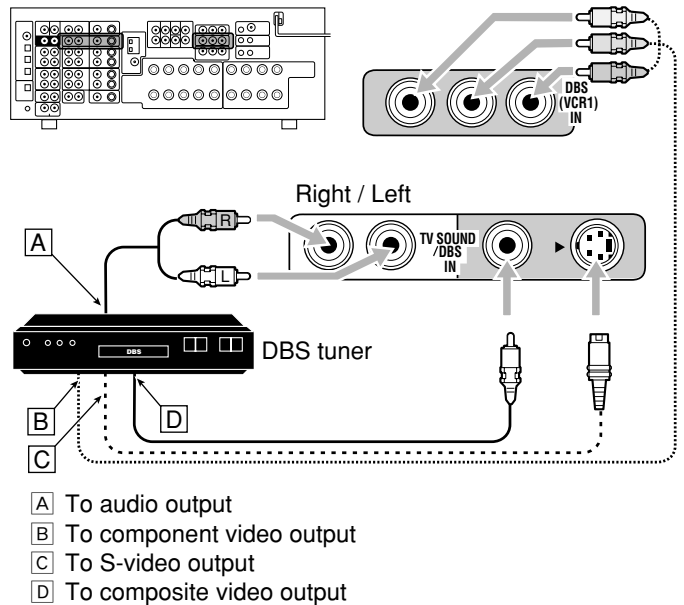
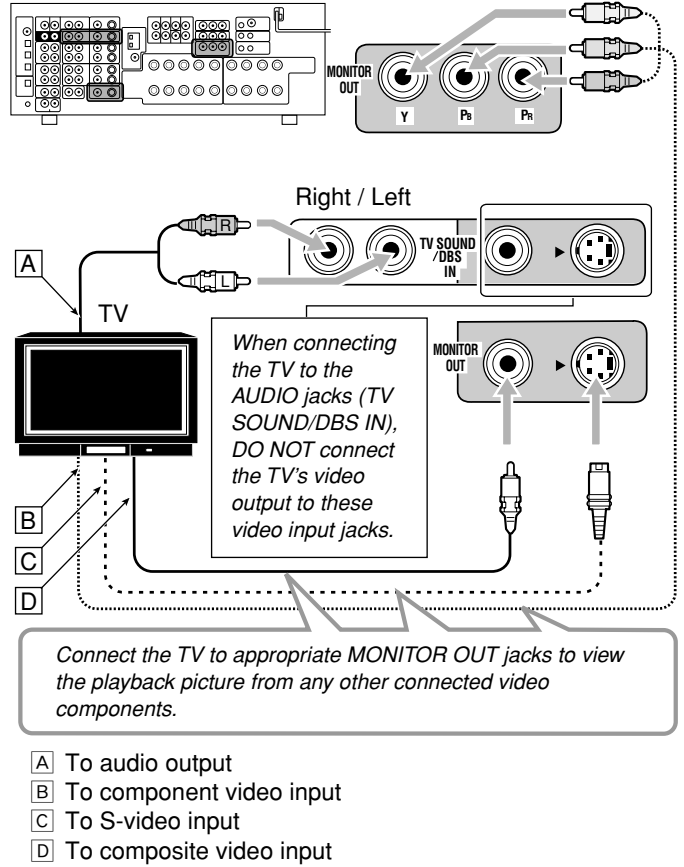

### Notes:

- When connecting a DBS tuner to the TV SOUND/DBS IN jacks, change the source name to "DBS," which will appear on the display when it is selected as the source. Otherwise, you cannot view any picture from DBS tuner. See page 24 for details.
- When connecting a DBS tuner to component video input jacks, make the component video input setting (VIDEO IN DBS) correctly. See page 38 for details.

## DVD player

To enjoy Dolby Digital and DTS multi-channel software (including Dual Mono software), connect the DVD player through the digital or analog discrete (DVD MULTI) terminals.

• **When you connect a DVD player with stereo output jacks:**

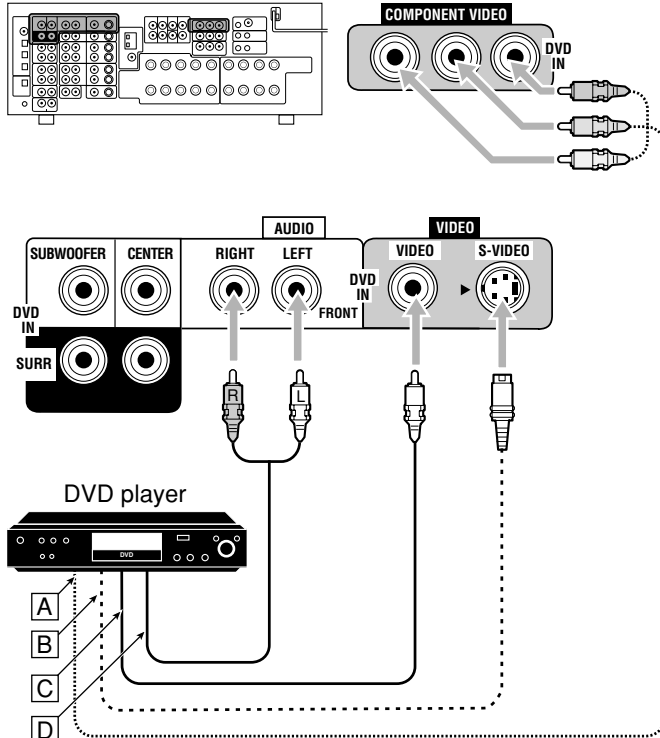

- A To component video output
- B To S-video output
- C To composite video output
- D To left/right front channel audio output (or to audio-mixed output if necessary)

**Note:**

When connecting a DVD player to the component video input jacks, make the component video input setting (VIDEO IN DVD) correctly. See page 38 for details.

• **When you connect a DVD player with its analog discrete output (5.1-channel reproduction) jacks:**

This connection is the best connection method for enjoying DVD Audio sounds.

- When a DVD Audio disc is played back, the original high-quality sounds can be reproduced only using this connection.

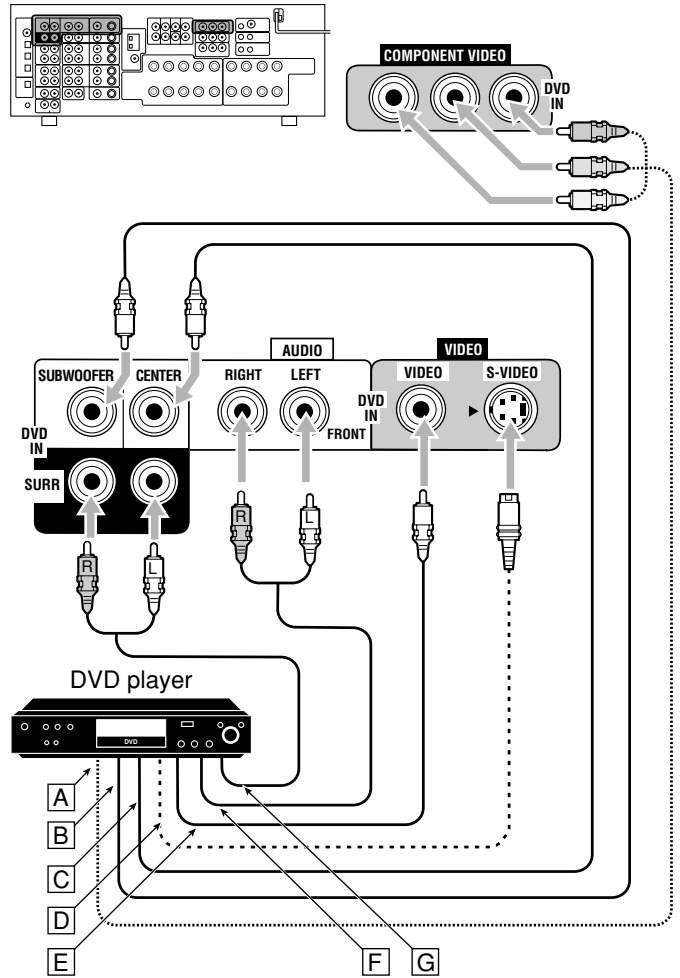

- A To component video output
- B To subwoofer output
- C To center channel audio output
- D To S-video output
- E To composite video output
- F To left/right front channel audio output
- G To left/right surround channel audio output

**Note:**

When connecting a DVD player to the component video input jacks, make the component video input setting (VIDEO IN DVD) correctly. See page 38 for details.

## Digital connections

This receiver is equipped with four DIGITAL IN terminals on the rear panel—one digital coaxial terminal and three digital optical terminals—and one DIGITAL OUT (optical) terminal on the rear panel. Another digital optical input terminal is located on the front panel (see page 11).

### IMPORTANT:

- When connecting video components using the digital terminals, you also need to connect it to the video jacks on the rear panel. Otherwise, you cannot view any playback picture.
- After connecting the components using the DIGITAL IN terminals, set the following correctly if necessary.
  - Set the digital input (DIGITAL IN) terminal setting correctly. For details, see "Setting the digital input terminals" on pages 37.
  - Select the digital input mode correctly. For details, see "Selecting the Analog or Digital Input Mode" on page 22.

### Digital input terminals

You can connect any digital components having coaxial or optical digital output terminal.

Digital coaxial cable (not supplied)  
between digital coaxial terminals



Digital optical cable (not supplied)  
between digital optical terminals

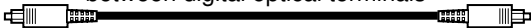

When the component has a digital coaxial output terminal, connect it to the DIGITAL 1 (DVD) terminal, using a digital coaxial cable (not supplied).

When the component has a digital optical output terminal, connect it to the DIGITAL 2 (CD), DIGITAL 3 (TV) or DIGITAL 4 (CDR) terminal, using a digital optical cable (not supplied).

Before connecting a digital optical cable, unplug the protective plug.

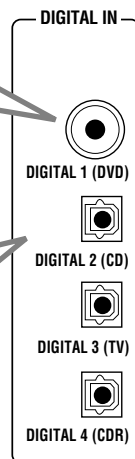
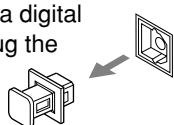

### Notes:

- When shipped from the factory, the DIGITAL IN terminals have been set for use with the following components:
  - DIGITAL 1 (coaxial): For DVD player
  - DIGITAL 2 (optical): For CD player
  - DIGITAL 3 (optical): For digital TV broadcast tuner
  - DIGITAL 4 (optical): For CD recorder
- When you want to operate a CD player, a CD recorder, and/or an MD recorder using the COMPULINK remote control system (see page 51), connect the target components with both digital and analog connections (see pages 10 and 11).
- When you want to operate a DVD player, a VCR, and/or a TV using the AV COMPULINK remote control system (see page 53), connect the target components with both digital and analog connections (see pages 12 and 13).

### Digital output terminal

You can connect any digital components which have an optical digital input terminal.

Digital optical cable (not supplied)  
between digital optical terminals



When the digital recording equipment such as a CD recorder has a digital optical input terminal, connecting it to the DIGITAL OUT terminal enables you to perform digital-to-digital recording.

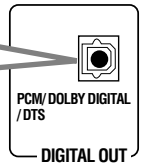

### Note:

The digital signal format transmitted through the DIGITAL OUT terminal is the same as that of the input signal. This means that when the DTS signals are input, the DTS signals are transmitted.

## Connecting the RF Rod Antenna and IR Signal Transmitter

The combination of the RF rod antenna and the IR signal transmitter allows you to use the multi-room function more conveniently. The remote control supplied with this receiver can transmit both RF and IR signal at the same time. This receiver catches the RF signals emitted from the remote control, and converts them into IR signals, then transmits the converted signals to the remote sensors on the other components through the IR signal transmitter. This means that you can control not only this receiver but also other components from Zone 2.

### Setting up the RF rod antenna

The remote control supplied with this receiver can transmit RF (Radio Frequency) signals as well as IR (infrared) signals. The RF rod antenna can receive the RF signals emitted from the remote control. So, with the RF rod antenna connected, you can operate the receiver at a distance of up to 15 m (50 feet) using RF signals sent from this receiver (more than twice as far as when using IR signals). Moreover, RF signals can go through walls and other objects in the house so you need not aim at the receiver directly. However, if the antenna cannot receive signals stably, you cannot operate the receiver correctly.

- Without the RF rod antenna connected, you can operate the receiver with the remote control, aiming the remote control directly at the remote sensor on the receiver.

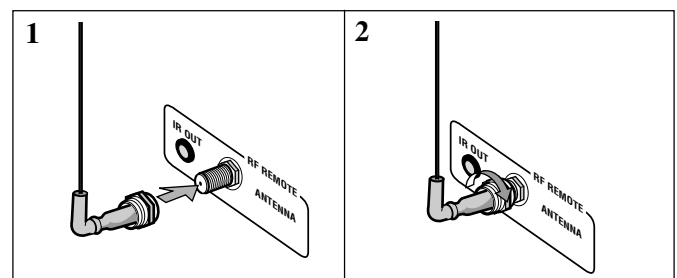

- Insert the RF rod antenna onto the RF REMOTE ANTENNA terminal.
- Rotate the fixing nut to attach the RF rod antenna firmly.



### Notes:

- The signal-reachable distance may differ depending on the operating conditions and circumstances. To improve transmitting conditions, change the distance to the receiver and the direction to transmit while operating the remote control.
- To avoid a failure in the reception from the remote control, keep the connecting cables and the IR signal transmitter's cable away from the RF rod antenna.

### Setting up the IR signal transmitter

The IR signal transmitter can retransmit the IR signals. The transmitter allows you to use the AV COMPULINK remote control system, and to operate other manufacturers' components without aiming the remote control directly at the remote sensors on the target components. In addition, the IR signal transmitter reduces the possibility of malfunction.

- The IR signal transmitter may not operate the target components depending on the operating conditions and circumstances—including the aiming angle and direction of the IR signal transmitter at the remote sensors of the target components. If this occurs, changing its aiming angle and direction at the remote sensors may solve the problem.

#### 1. Find a place where you can attach the IR signal transmitter.

- Place the transmitter where the signal can reach the remote sensor of the target components in a direct line of sight.
- If the cord length of the IR signal transmitter is not long enough, use an extension cord (not supplied).

#### 2. Attach the double-sided adhesive tape (supplied) to the IR signal transmitter.

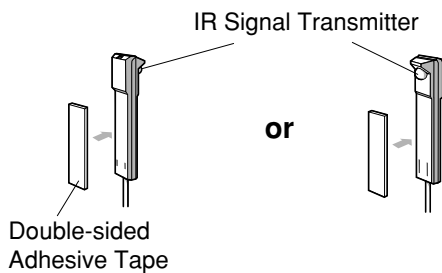

#### 3. Connect the plug of the transmitter to the IR OUT terminal of the receiver and attach the transmitter.

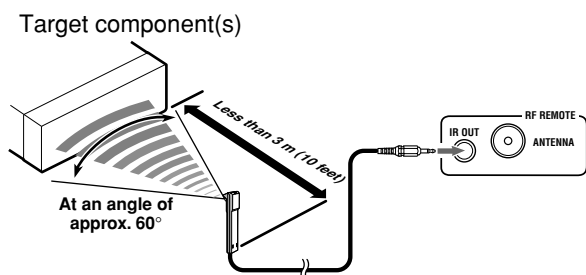

#### Signal-emitting angle of the transmitter

Horizontally: 60°

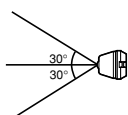

Vertically: 60°

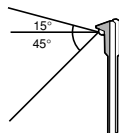

### Connecting the Power Cord

Before plugging the receiver into an AC outlet, make sure that all connections have been made.

#### Plug the power cord into an AC outlet.

Keep the power cord away from the connecting cables and the antenna. The power cord may cause noise or screen interference.

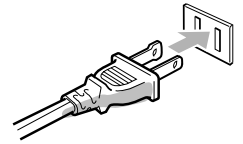

#### Note:

The preset settings such as preset channels and sound adjustment may be erased in a few days in the following cases:

- When you unplug the power cord.
- When a power failure occurs.

#### CAUTIONS:

- Do not touch the power cord with wet hands.
- Do not pull on the power cord to unplug the cord. When unplugging the cord, always grasp the plug so as not to damage the cord.

### Putting Batteries in the Remote Control

Before using the remote control, insert the two supplied batteries first.

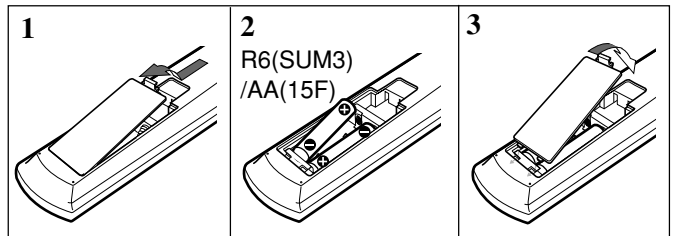

#### 1. On the back of the remote control, remove the battery cover.

#### 2. Insert the batteries.

- Make sure to match the polarity: (+) to (+) and (–) to (–).

#### 3. Replace the cover.

If the remote control cannot transmit signals or operate the receiver correctly, replace the batteries. Use two R6(SUM3)/AA(15F) type (alkaline) dry-cell batteries.

#### Notes:

- When you aim the remote control directly at the remote sensor on the receiver, you can operate the receiver at a distance of up to 7 m (23 feet).
- After replacing the batteries, set the manufacturers' codes again (see pages from 59 to 62).

#### CAUTIONS:

Follow these precautions to avoid leaking or cracking cells:

- Place batteries in the remote control so they match the polarity: (+) to (+) and (–) to (–).
- Use the correct type of batteries. Batteries that look similar may differ in voltage.
- Always replace both batteries at the same time.
- Do not expose batteries to heat or flame.

# Multi-room Operations

Before operating this receiver any further, be familiar with this multi-room function.

This function enables you to listen to different sources in two different places (we call these two places "Zone 1 (main room)" and "Zone 2 (sub-room)" by using this receiver.

This section explains only the required speaker connections, the concept, and basic operations of the multi-room function. For more detailed operations, see the respective pages in this manual.

## Required Connections for Zone 2

Connect front speakers by using one of the methods described below (either Connection **A** or Connection **B**).

**Zone 2 layout**

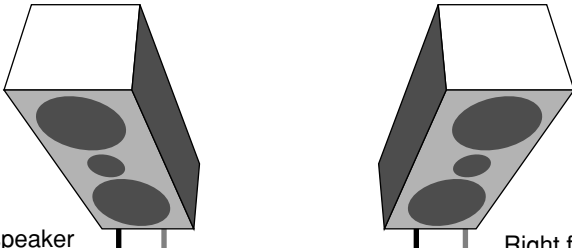

**Connection A**

Connect the input jacks of another amplifier to the ZONE 2 PREOUT jacks on the rear panel, using a cable with RCA pin plugs (not supplied).

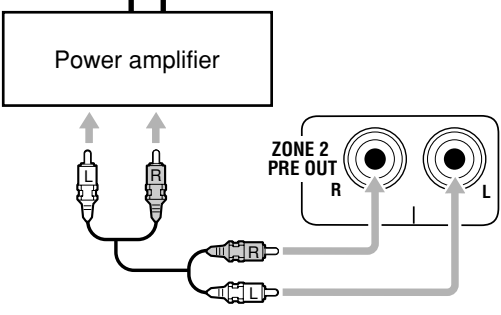

**Connection B**

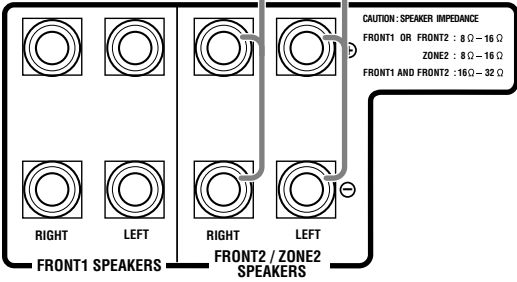

CAUTION: SPEAKER IMPEDANCE  
FRONT1 OR FRONT2 : 8 Ω - 16 Ω  
ZONE2 : 8 Ω - 16 Ω  
FRONT1 AND FRONT2 : 16 Ω - 32 Ω

**Merit:**  
This connection DOES allow you to always use the Surround/DSP mode using the center, surround, and surround back speakers (see pages 42 to 49) for the Zone 1 source.

**Demerit:**  
This connection DOES require another amplifier.

**To use the Zone 2 front speakers connected through the ZONE 2 PREOUT jacks**  
Turn on and operate the other amplifier connected to the ZONE 2 PREOUT jacks correctly.

**Note:**  
*Usage of long audio cables/long speaker signal cables will deteriorate the signals and degrade the sound quality.*

**Merit:**  
This connection DOES NOT require another amplifier.

**Demerits:**

- When the Zone 2 speakers are activated, this connection DOES NOT allow you to use the Surround/DSP modes using the center, surround, and surround back speakers (see pages 42 to 49) and the DVD MULTI playback mode (see page 50) for the Zone 1 source.
- When the Surround/DSP modes using the center, surround, and surround back speakers, or when the DVD MULTI playback mode is activated for the Zone 1 source, this connection DOES NOT allow you to use the Zone 2 speakers.

**To use the Zone 2 front speakers connected to the FRONT2/ ZONE2 SPEAKERS terminals**  
See "Setting the Zone 2/Speakers 2 Usage" on page 38, and "Activating the Zone 2 Front Speakers" on page 29.

**Note:**  
*Usage of long speaker signal cables will deteriorate the signals and degrade the sound quality.*

## Basic Operating Procedure for Zone 1

### On the front panel:

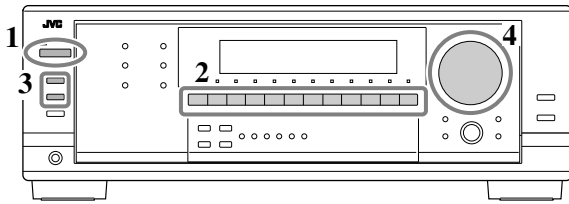

#### 1. Press **⏻/STANDBY/ON**.

The STANDBY lamp goes off, and the ZONE 1 indicator lights up on the display.

The buttons and controls on the unit work for Zone 1 operations.

- For more details, see “Turning the Power On and Off (Standby)” on page 19.

The last Zone 1 source appears.

The ZONE 1 indicator lights up.

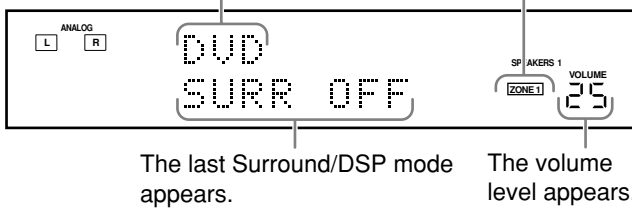

The last Surround/DSP mode appears.

The volume level appears.

#### 2. Press one of the source selection buttons to select a source and start playback.

The sound comes out of the Zone 1 speakers.

- For more details, see “Selecting the Zone 1 Source to Play” on page 20.

#### 3. If no sound comes out of the front speakers, press **SPEAKERS ON/OFF 1** and/or **SPEAKERS ON/OFF 2/ZONE2** which you want to use.

The selected front speaker indicator(s) light(s) up on the display.

- For more details, see “Activating the Zone 1 Front Speakers” on page 21.

#### 4. Turn **MASTER VOLUME** to adjust the volume level of the sound through the Zone 1 speakers.

- For more details, see “Adjusting the Zone 1 Volume” on page 21.

### On the remote control:

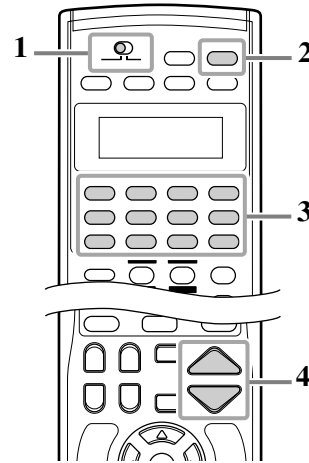

#### 1. Set **ZONE 1/ZONE 2** selector to **ZONE 1**.

Now the buttons on the remote control work for Zone 1 operations.

#### 2. Press **AUDIO POWER ON**.

The STANDBY lamp goes off on the front panel, and the ZONE 1 indicator lights up on the unit's display.

- For more details, see “Turning the Power On and Off (Standby)” on page 19.

#### 3. Press one of the source selection buttons to select a source and starts playback.

The sound comes out of the Zone 1 front speakers.

- For more details, see “Selecting the Zone 1 Source to Play” on page 20.
- If no sound comes out of the front speakers, press **SPEAKERS ON/OFF 1** and/or **SPEAKERS ON/OFF 2/ZONE2** on the front panel. The selected front speaker indicator(s) light(s) up on the unit's display. For more details, see “Activating the Zone 1 Front Speakers” on page 21.

#### 4. Press **VOLUME +/-** to adjust the volume level through the Zone 1 speakers.

- For more details, see “Adjusting the Zone 1 Volume” on page 21.

## Basic Operating Procedure for Zone 2

The sources and functions available for Zone 2 operations are limited.

For more details on Zone 2 operations, see “Zone 2 (Sub-room) Operations” on pages 26 to 29.

### On the front panel:

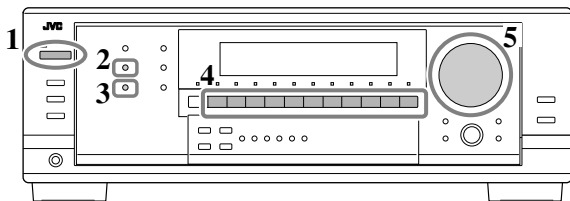

#### 1. Press **⏻/I** STANDBY/ON.

The STANDBY lamp goes off, and the ZONE 1 indicator lights up on the display.  
The buttons and controls on the unit work for Zone 1 operations.

#### 2. Press **ZONE 2 ON/OFF** to activate ZONE 2.

The ZONE 2 indicator lights up.  
• For more details, see “Turning the Power On and Off (Standby) and Selecting the Zone 2 Operations” on page 26.

#### 3. Press **ZONE 2 CONTROL** so that “ZONE2” and the previously selected Zone 2 source name appear on the display.

Now the buttons and controls on the unit work for Zone 2 operations.

“ZONE2” appears.

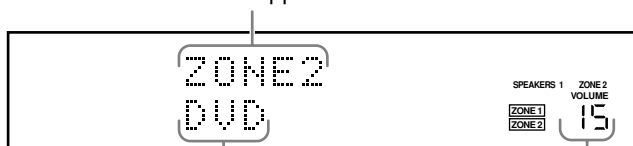

The last Zone 2 source appears.

The Zone 2 volume level appears.

#### 4. Press one of the source selection buttons (except DVD MULTI) to select a source and start playback.

The sound comes out of the Zone 2 front speakers.  
• For more details, see “Selecting the Zone 2 Source to Play” on page 28.  
• If no sound comes out of the Zone 2 front speakers, see “Activating the Zone 2 Front Speakers” on page 29.

#### **Note:**

When “TV” has been assigned as the source to the TV SOUND/DBS button, it does not work. To change the source name, see “Changing the Source Name” on page 24.

#### 5. Turn **MASTER VOLUME** to adjust the volume level of the sound through the Zone 2 front speakers.

• For more details, see “Adjusting the Zone 2 Volume” on page 28.

### On the remote control:

When operating the receiver using the remote control, the unit’s display always shows the Zone 1 source information though you are operating it for the Zone 2 source.

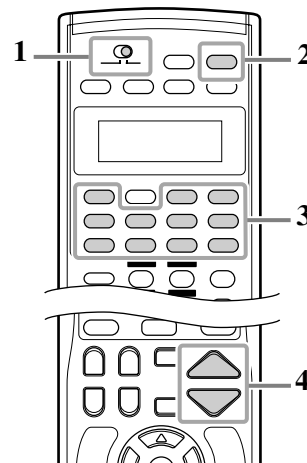

#### 1. Set **ZONE 1/ZONE 2** selector to ZONE 2.

Now the buttons on the remote control work for Zone 2 operations.

#### 2. Press **AUDIO POWER ON**.

The STANDBY lamp on the front panel goes off, and the ZONE 2 indicator lights up on the unit’s display.

#### 3. Press one of the source selection buttons (except DVD MULTI) to select and play a source.

The sound comes out of the Zone 2 front speakers.

- For more details, see “Selecting the Zone 2 Source to Play” on page 28.
- If no sound comes out of the Zone 2 front speakers, see “Activating the Zone 2 Front Speakers” on page 29.

#### **Note:**

When “TV” has been assigned as the source to the TV/DBS button, it does not work. To change the source name, see “Changing the Source Name” on page 24.

#### 4. Press **VOLUME +/-** to adjust the volume level of the sound through the Zone 2 front speakers.

• For more details, see “Adjusting the Zone 2 Volume” on page 28.

# Zone 1 (Main Room) Operations

This section explains only the operations commonly used when you play any sound source in Zone 1 (main room). See pages 26 to 29 for the Zone 2 (sub-room) operations.

- Before performing Zone 1 operations, it is recommended to finish the basic settings on pages 32 to 38.

## IMPORTANT:

Check the following before or while using the buttons and controls.

### For Zone 1 operations:

The ZONE 1 indicator lights up on the unit's display.

- **When using the unit:**
  - “ZONE2” is not shown in the unit's main display.
- **When using the remote control:**
  - Set the ZONE 1/ZONE 2 selector to **ZONE 1**.
  - Check the indication shown on the remote's display when you press a button—this indicates the remote control operation mode together with multi-room operation mode (either for ZONE 1 or ZONE 2) for about two hours.

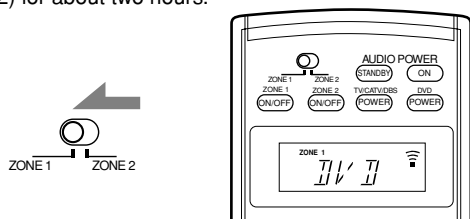

Ex. When you press DVD with ZONE 1/ZONE 2 selector set to ZONE 1.

## On the remote control:

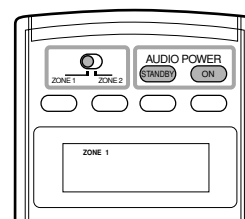
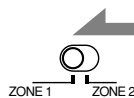

**To turn on the power,** press AUDIO POWER ON.

The STANDBY lamp goes off, and the ZONE 1 indicator lights up on the unit's display.

The currently selected SPEAKERS 1 and/or 2 indicator(s) also light(s) up on the unit's display.

- If neither the SPEAKERS 1 nor 2 indicator is lit, see “Activating the Zone 1 Front Speakers” on page 21.

**To turn off the power (into standby mode),**

press AUDIO POWER STANDBY.

The STANDBY lamp lights up.

## Notes:

- A small amount of power is consumed in standby mode. To turn the power off completely, unplug the AC power cord.
- If you have turned off the receiver with the volume level set at more than level “30,” the volume level will be automatically set at level “30” next time you turn on the receiver.
- Before you turn off the receiver in Zone 1, make sure that no one is listening to any source in Zone 2 (the ZONE 2 indicator is lit on the display) since the Zone 2 sound will also be turned off unexpectedly.

## Turning the Power On and Off (Standby)

### On the front panel:

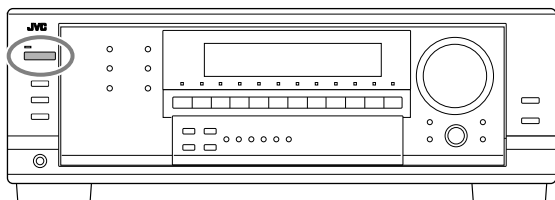

**To turn on the power,** press  $\phi$ /I STANDBY/ON.

The STANDBY lamp goes off, and the ZONE 1 indicator lights up on the display.

The last Zone 1 source appears.

The ZONE 1 indicator lights up.

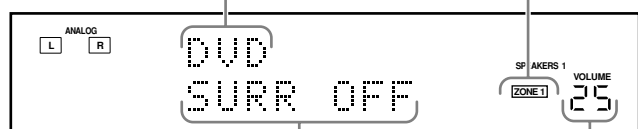

The last Surround/DSP mode appears.

The volume level appears.

The currently selected SPEAKERS 1 and/or 2 indicator(s) also light(s) up on the display.

- If neither the SPEAKERS 1 nor 2 indicator is lit on the display, see “Activating the Zone 1 Front Speakers” on page 21.

**To turn off the power (into standby mode),**

press  $\phi$ /I STANDBY/ON again.

The STANDBY lamp lights up.

## Canceling the Zone 1 Operations

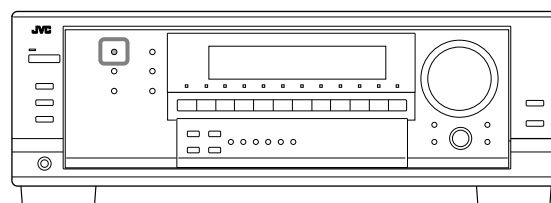

**To stop Zone 1 operations and sounds from the Zone 1 speakers,** press ZONE 1 ON/OFF on the unit or the remote control so that the ZONE 1 indicator goes off from the display.

The currently selected front speakers indicator(s) also go(es) off from the display (no sound will be heard in Zone 1).

**To use this receiver for Zone 1 operations again,** press ZONE 1 ON/OFF again (the ZONE 1 indicator lights up).

The front speakers indicator(s) previously selected light(s) up. Now the buttons and controls on the unit work for Zone 1 operations.

## Note:

If “TURN ON ZONE1 OR ZONE2” appears on the display, press ZONE 1 ON/OFF or ZONE 2 ON/OFF to listen to the sound in Zone 1 or in Zone 2; Otherwise, the receiver will turn off after about 1 minute.

## Selecting the Zone 1 Source to Play

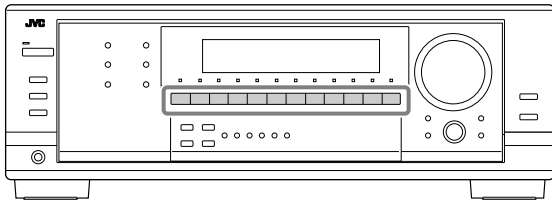

Press one of the source selection buttons.

- When you have connected digital source components using the digital terminals, change the input mode for these components to the digital input mode (see page 22).

Ex. When VCR 1 is selected as the source.

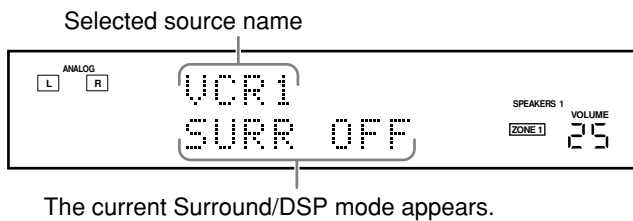

The current Surround/DSP mode appears.

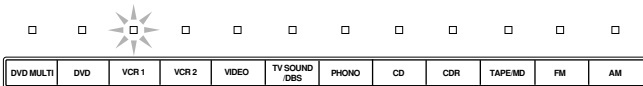

On the front panel

- The lamp on the selected source lights up (ex. when VCR 1 is selected as the source).



On the remote

### Notes:

- When connecting an MD recorder (to the TAPE/MD IN jacks), and a DBS tuner (to the TV SOUND/DBS IN jacks), change the source names shown on the display. For details, see "Changing the Source Name" on page 24.
- When you press one of the audio source selection buttons (PHONO, CD, TAPE/MD, CDR, FM or AM) on the remote control, the receiver automatically turns on. If you turn on the receiver with the ZONE 1/ZONE 2 selector set to ZONE 2, press ZONE 1 ON/OFF to activate Zone 1 operations.
  - While Zone 1 is deactivated, press one of the audio source selection buttons on the remote control with the ZONE 1/ZONE 2 selector set to ZONE 1 to activate Zone 1 operations.
- When you select DVD MULTI, you can enjoy analog discrete output sound (5.1-channel surround reproduction) from the external component.
  - You may need to select analog discrete output mode on the external component.
  - When using the headphones, you can listen to the front channel sounds (left and right) only.
  - The Surround modes (see page 42) and DSP modes (see page 48) cannot be applied to DVD MULTI playback mode.

## Speaker and signal indicators on the display

By checking the following indicators, you can easily confirm which speakers you are activating and which signals are coming into this receiver.

Speaker indicators	Signal indicators
L C R	L C R
SUBWFR LFE	LFE
LS S RS	LS S RS
SB	SB

What speaker indicators light depends on the speaker setting (For details, see "Setting the speakers" on page 34.)

- The frames of "L," "C," "R," "LS," "RS," and "SB" light up, when the corresponding speakers are set to "LARGE" or "SMALL" and when the speaker is required for the Surround/DSP mode currently selected.
- When "SUB WOOFER" is set to "YES," SUBWFR lights up (see page 34).
- All three frames on the row of "SB" are not used at the same time. When "SBACK OUT" is set to "2SPK," the left and the right ones are used. When it is set to "1SPK," the middle one is used (see page 34).

The signal indicators light up to show the incoming signals.

- L: • **When digital input is selected:** Lights up when the left channel signal comes in.  
 • **When analog input is selected:** Always lights up.
- R: • **When digital input is selected:** Lights up when the right channel signal comes in.  
 • **When analog input is selected:** Always lights up.
- C: Lights up when the center channel signal comes in.
- LFE: Lights up when the LFE channel signal comes in.
- LS: Lights up when the left surround channel signal comes in.
- RS: Lights up when the right surround channel signal comes in.
- S: Lights up when the monaural surround channel signal comes in.
- SB: Lights up when the surround back channel signal comes in.

### Note:

When DVD MULTI is selected as the source, "L," "C," "R," "LFE," "LS," and "RS" light up.

### How to understand the speaker and signal indicator illumination

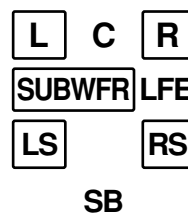

Ex. No sound comes out of the center speaker and surround back speakers though center channel and surround back channel signals are coming into this receiver.

## Selecting different sources for picture and sound

While watching pictures from a video source (DVD player, VCR, or DBS tuner), you can listen to sound of an audio source.

- Once you have selected a video source, pictures of the selected source are sent to the TV until you select another video source.

Press one of the audio source selection buttons—PHONO, CD, TAPE/MD, CDR, FM, AM—while viewing the picture from a video component such as the VCR or DVD player, etc.

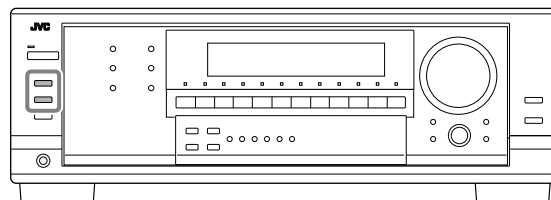
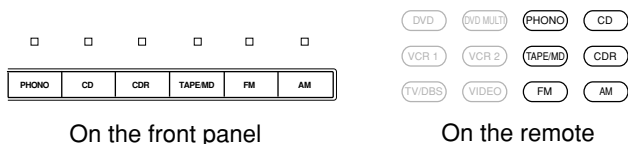

To use the speakers connected to the FRONT1 SPEAKERS terminals, press SPEAKERS ON/OFF 1 so that the SPEAKERS 1 indicator lights up on the display.

- Make sure that the SPEAKERS 2 indicator is not lit.

To use the speakers connected to the FRONT2/ZONE2 SPEAKERS terminals, press SPEAKERS ON/OFF 2/ZONE 2 so that the SPEAKERS 2 indicator lights up on the display.

- Make sure that the SPEAKERS 1 indicator is not lit.

To use both sets of the speakers connected to the FRONT1 SPEAKERS and FRONT2/ZONE2 SPEAKERS terminals, press SPEAKERS ON/OFF 1 and SPEAKERS ON/OFF 2/ZONE 2 so that the SPEAKERS 1/2 indicators light up on the display.

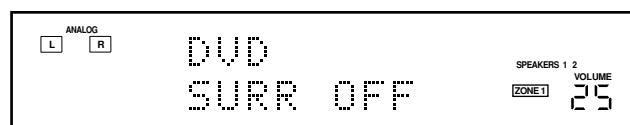

Ex. When both sets of the speakers selected.

## Adjusting the Zone 1 Volume

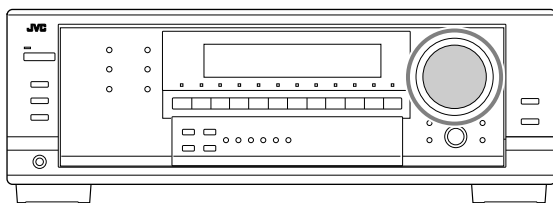

### On the front panel:

To increase the volume, turn MASTER VOLUME clockwise.  
To decrease the volume, turn it counterclockwise.

### On the remote control:

To increase the volume, press VOLUME +.  
To decrease the volume, press VOLUME -.

### Notes:

- The volume level can be adjusted within the range of "0" (minimum) to "70" (maximum).
- If you set "ONE TOUCH OPE" (One Touch Operation) to "ON" (see page 38), you do not have to adjust the volume level each time you change the source. It is automatically set to the stored level.
- If you have turned off the receiver with the volume level set at more than level "30," the volume level will be automatically set at level "30" next time you turn on the receiver.

### CAUTIONS:

- Always set the volume to the minimum before starting any source. If the volume is set at a high level, the sudden blast of sound energy can permanently damage your hearing and/or ruin your speakers.
- Be careful not to turn up the volume too high when controlling the receiver without listening to the playback sound. For example, when adjusting the volume level in Zone 2 from Zone 1.

## Activating the Zone 1 Front Speakers



When shipped from the factory, both pairs of the front speakers have been set to be used in Zone 1.

- To use the speakers connected to the FRONT2/ZONE2 SPEAKERS terminals, set the speaker usage correctly. (See "Setting the Zone 2/Speakers 2 usage" on page 38.)

When you have connected two pairs of front speakers and placed them in Zone 1, you can select which to use.

### Note:

When you select "DVD MULTI" as the source or any one of the Surround/DSP mode which activates the center and/or surround speaker(s), you can use only one set of the speakers.

To use neither set of the speakers connected to the FRONT1 SPEAKERS and FRONT2/ZONE2 SPEAKERS terminals, press SPEAKERS ON/OFF 1 and SPEAKERS ON/OFF 2/ZONE 2 so that the SPEAKERS 1/2 indicators go off from the display.

- Activating the speakers turns on the Surround and DSP modes previously selected.

### Listening with headphones only:

Connect headphones to the PHONES jack, and deactivate both sets of the front speakers so that "HEADPHONE" appears and the HEADPHONE indicator lights up on the display.

- You can listen to left and right channel sound with headphones.
- Make sure that all the speaker indicators are not lit.

You can enjoy the sound effects through the headphones when Surround or DSP mode is activated—3D Headphone (3D H PHONE) mode.

- "3D H PHONE" appears and the DSP and HEADPHONE indicators light up on the display. (For details, see pages 47 and 48.)

### Note:

3D Headphone (3D H PHONE) mode is not valid for DVD MULTI playback mode.

### CAUTION:

Be sure to turn down the volume:

- Before connecting or putting on headphones, as its high volume can damage both the headphones and your hearing.
- Before turning on the speakers again, as its high volume may come out of the speakers.

## Turning On and Off the Subwoofer Sound



You can cancel the subwoofer sound output even though you have connected a subwoofer and have set "SUB WOOFER" to "YES" (see page 34).

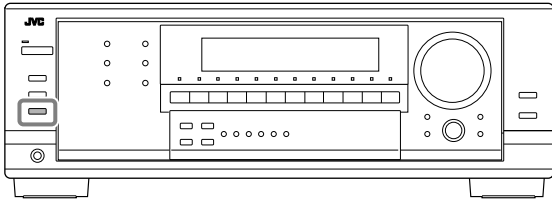

Press **SUBWOOFER OUT ON/OFF** to cancel the subwoofer sound output.

Each time you press the button, subwoofer sound output is deactivated ("SUBWFR OFF") and activated ("SUBWFR ON") alternately.

- When subwoofer output is canceled, the **SUBWFR** indicator goes off. Bass sounds (and LFE signals) will be emitted through the front speakers (except for DVD MULTI playback mode).
- When subwoofer sound output is activated, subwoofer output level can be adjusted (see pages 40 and 41).

### Notes:

- The **SUBWOOFER OUT ON/OFF** button does not work when you set "SMALL" for the front speakers on the **Speaker size** setting (see page 34) or using **Quick Speaker Setup** (see page 32).
- You cannot activate the subwoofer output when you have set "SUB WOOFER" to "NO" (see pages 32 and 34).
- When you change the "SUB WOOFER" setting from "NO" to "YES" (see page 34), subwoofer output is automatically activated.

## Selecting the Analog or Digital Input Mode

When you have connected digital source components using the digital terminals (see pages 11 and 14), change the input mode for these components to the digital input mode.

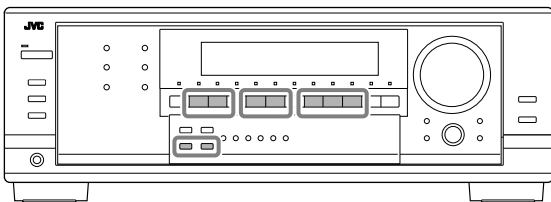

Before you start, remember...

- The digital input terminal setting should be properly done for the sources you want to select the digital input mode (see "Setting the digital input terminals" on page 37).
- The digital input can be used for the Zone 1 sources. The analog input is always selected as the Zone 2 source without respect to this setting.

1. Press one of the source selection buttons (DVD, VCR 1, TV SOUND/DBS, VIDEO, CD, CDR, or TAPE/MD\*) for which you want to change the input mode.

\* If "TAPE" has been assigned to the TAPE/MD button, it does not work in this step. To change the source name, see "Changing the Source Name" on page 24.

2. Press **INPUT DIGITAL** to select "DGTL AUTO."

- When using the remote control, press **ANALOG/DIGITAL**. Each time you press the button, the analog (ANALOG) and digital (DGTL AUTO) input modes alternate.

The **DIGITAL AUTO** indicator lights up on the display.

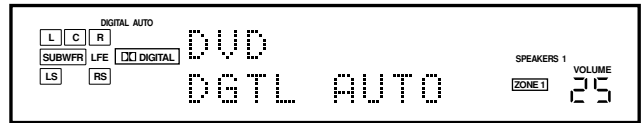

- When selecting "DGTL AUTO," the following indicators show the digital signal format of the incoming signal.

**LINEAR PCM** : Lights up when Linear PCM signals come in.

**DIGITAL** : Lights up when Dolby Digital signals come in.

**dts** : Lights up when DTS signals come in.

No indicator lights up when the receiver cannot recognize the digital signal format of the incoming signals.

### Note:

For the details of digital signal formats, see pages 42 and 43.

When playing software encoded with Dolby Digital or DTS, the following symptoms may occur:

- Sound does not come out at the beginning of playback.
- Noise comes out while searching for or skipping chapters or tracks.

In this case, press **INPUT DIGITAL** repeatedly to select "DGTL D.D" or "DGTL DTS" while "DGTL AUTO" still remains on the display.



- Each time you press **INPUT DIGITAL**, the input mode changes as follows:

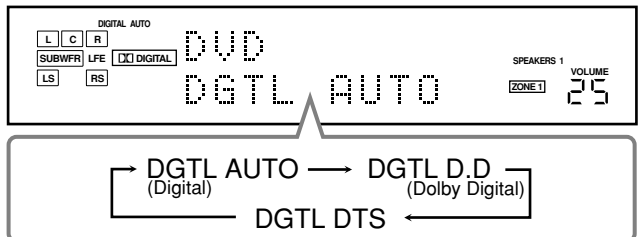

When "DGTL D.D" or "DGTL DTS" is selected, the **AUTO** indicator goes off, and the corresponding digital signal format indicator lights up on the display.

- If the incoming signal does not match the selected digital signal format, the frame of the selected indicator will flash.

### Note:

When you turn off the power or select another source, "DGTL D.D" and "DGTL DTS" settings are canceled and the digital input mode is automatically reset to "DGTL AUTO."

To select the analog input mode again

Press **INPUT ANALOG** (or press **ANALOG/DIGITAL** on the remote control repeatedly until "ANALOG" appears on the display). The **ANALOG** indicator lights up.



## Setting the Dynamic Range

You can enjoy a powerful sound at night using Midnight Mode.

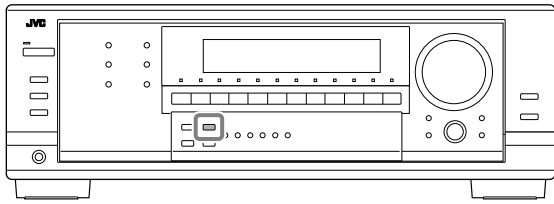

Press **MIDNIGHT MODE** so that “**MID NIGHT: 1**” or “**MID NIGHT: 2**” appear on the display.

The MIDNIGHT MODE indicator also lights up.

<b>MID NIGHT: 1</b>	Select when you want to reduce the dynamic range a little.
<b>MID NIGHT: 2</b>	Select when you want to apply the compress effect fully (useful at midnight).
<b>MID NIGHT: OFF</b>	Select when you want to enjoy surround with its full dynamic range (no effect applied).

### Notes:

- If Analog Direct is in use (see the right column), Midnight Mode is temporarily canceled.
- Midnight Mode is not valid for DVD MULTI playback mode.

## Attenuating the Input Signal



When the input level of the analog source is too high, the sounds will be distorted. If this happens, you need to attenuate the input signal level to prevent the sound distortion.

- Once you have made an adjustment, it is memorized for each analog source.

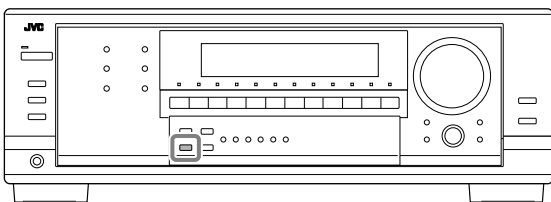

Press and hold **INPUT ATT (INPUT ANALOG)** so that the **INPUT ATT** indicator lights up on the display.

- Each time you press and hold the button, the input attenuator mode turns on (“ATT ON”) or off (“NORMAL”).

### Notes:

- This function is applied to only the Zone 1 analog sources.
- This function is not valid when DVD MULTI is selected or when Analog Direct is activated.

## Turning Analog Direct On and Off

You can enjoy the sound closer to the original source by overriding the sound adjustments such as Midnight Mode (see the left column), Bass Boost (see page 24), Equalization pattern (see page 40), speaker output level adjustments (see page 40), and Surround and DSP modes (see pages 42 to 49). You can only adjust the volume level and the subwoofer output level while Analog Direct is in use.

- Once you have made an adjustment, it is memorized for each analog source.

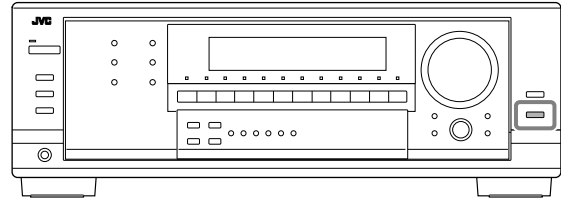

Press **ANALOG DIRECT** so that “**A DIRECT**” appears on the display.

The lamp on the button also lights up.

- Each time you press the button, Analog Direct turns on and off (the lamp goes off) alternately.

### Notes:

- This function is applied to only the Zone 1 analog sources.
- When digital input mode is in use, Analog Direct is not available.
- Turning on Surround or DSP mode cancels Analog Direct and previously selected sound adjustments are recalled.
- If Analog Direct is in use, Midnight Mode (see the left column) is temporarily canceled.
- Turning on Analog Direct cancels Input Attenuator (see the left column) and CC Converter (see below).

## Making Sounds Natural

JVC's CC (Compression Compensative) Converter eliminates jitter and ripples, achieving a drastic reduction in digital distortion by processing the digital music data in 24 bit-quantization and by expanding the sampling frequency to 128 kHz (for fs 32 kHz signals)/176.4 kHz (for fs 44.1 kHz signals)/192 kHz (for fs 48 kHz signals) on the front speakers.

By using the CC Converter, you can obtain a natural sound field from both digital and analog sources.

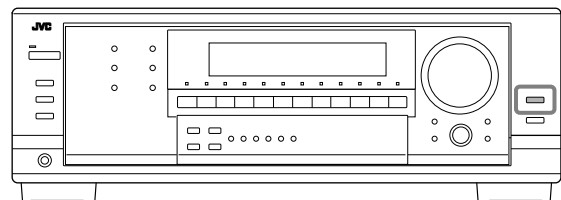

Press **CC CONVERTER** so that the lamp on the button lights up.

- Each time you press the button, CC Converter turns on and off (the lamp goes off) alternately.

### Notes:

- This function is applied to only the Zone 1 sources.
- You cannot use this function while Analog Direct is in use. If you turn on Analog Direct while this function is in use, this function will be canceled.



## Using the Sleep Timer



Using the Sleep Timer, you can fall asleep while listening to music. When the shut-off time comes, the receiver turns off automatically.

- Sleep Timer works only for the Zone 1 source.

### Press SLEEP repeatedly.

The SLEEP indicator lights up on the unit's display, and the shut-off time changes in 10-minute intervals:

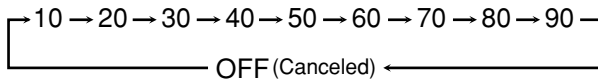

### When the shut-off time comes

The receiver turns off automatically.

- If the Zone 2 source is still playing (the ZONE 2 indicator is lit) when the shut-off time comes, the receiver will not turn off, but only the Zone 1 source will shut off.

### To check or change the time remaining until the shut-off time

Press SLEEP once.

The remaining time until the shut-off time appears in minutes.

- To change the shut-off time, press SLEEP repeatedly.

### To cancel the Sleep Timer

Press SLEEP repeatedly until "SLEEP OFF" appears on the unit's display. The SLEEP indicator goes off.

- Turning off the power also cancels the Sleep Timer.

## Recording a source

### For analog-to-analog recording

You can record any analog playback source onto the recording components connected to the audio output jacks on the rear panel at the same time.

### For digital-to-digital recording

You can record the currently selected digital input source through the receiver to a digital recording device connected to the DIGITAL OUT terminal.

### Notes:

- Analog-to-digital and digital-to-analog recordings are not possible.
- The output volume level, Midnight Mode (see page 23), Bass Boost (see page 24), Equalization patterns (see page 40), Surround and DSP modes (see pages 42 to 49) cannot affect the recording.

### IMPORTANT:

- While recording, do not turn off the receiver or Zone 1 source; otherwise, recording will stop.
- If the same source is selected both for Zone 1 and Zone 2, operating the Zone 2 source will affect the recording.

## Basic adjustment auto memory

This receiver memorizes sound settings for each Zone 1 source—

- when you turn off the power,
- when you change the source,
- when you press ZONE 1 ON/OFF or ZONE 2 CONTROL, and
- when you change the source name (see page 24).

When you change the source, the memorized settings for the newly selected source are automatically recalled.

The following can be stored for each source:

- Analog/digital input mode (see page 22)
- Midnight Mode (see page 23)
- Input attenuator mode (see page 23)
- Analog Direct (see page 23)
- CC Converter (see page 23)
- Bass Boost setting (see page 24)
- Equalization pattern (see page 40)
- Speaker output levels (see page 40)
- Surround and DSP mode selection (see pages 44 to 49)

### Notes:

- The memorized settings are not applied when a source is selected for Zone 2.
- If you want to memorize the volume level with the above settings, set One Touch Operation to "ON" (see page 38).

# Zone 2 (Sub-room) Operations Zone 2

This section explains only the operations used when you play a sound source in Zone 2 (sub-room). See pages 19 to 25 for the Zone 1 (main room) operations.

- Before performing the Zone 2 operations, it is recommended to finish the basic settings on pages 32 to 38.

## IMPORTANT:

Check the following before or while using the buttons and controls.

### For Zone 2 operations:

The ZONE 2 indicator lights up on the unit's display.

- **When using the unit:**
  - “ZONE2” is shown in the unit's main display.
- **When using the remote control:**

**When operating the receiver using the remote control, the unit's display always shows the Zone 1 source information though you are operating it for the Zone 2 source.**

- Set the ZONE 1/ZONE 2 selector to **ZONE 2**.
- Check the indication shown on the remote's display when you press a button—this indicates the remote control operation mode together with multi-room operation mode (either for ZONE 1 or ZONE 2) for about two hours.

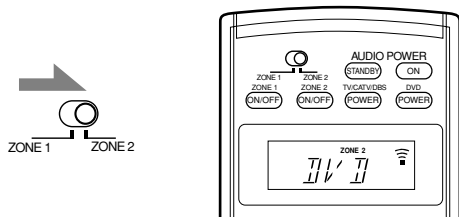

Ex. When you press DVD with ZONE 1/ZONE 2 selector set to ZONE 2.

## Note:

While the Zone 2 front speakers are activated, you cannot use the center, surround, and surround back speakers for the Surround/DSP modes in Zone 1.

**For those who connect the Zone 2 front speakers to the ZONE 2 PREOUT jacks through another amplifier (see page 16)**

### To use the Zone 2 front speakers

1. Turn on the other amplifier connected to the ZONE 2 PREOUT jacks.
2. Adjust the volume level of the Zone 2 front speakers through this receiver.

## Turning the Power On and Off (Standby) and Selecting the Zone 2 Operations

*On the front panel:*

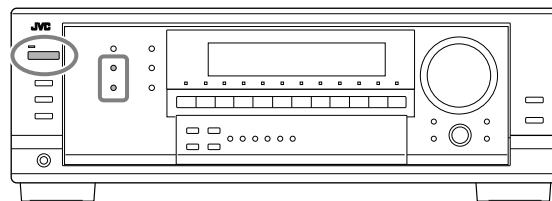

### 1. Press **STANDBY/ON**.

The STANDBY lamp goes off, and the ZONE 1 indicator lights up on the display.

- The buttons and controls on the unit work for Zone 1 operations.

The last Zone 1 source appears.

The ZONE 1 indicator lights up.

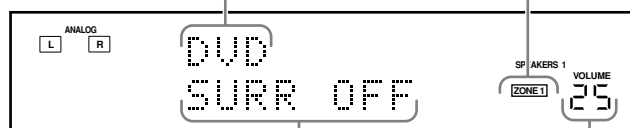

The last Surround/DSP mode appears.

The volume level appears.

The currently selected SPEAKERS 1 and/or 2 indicator(s) also light(s) up on the display.

### 2. Press **ZONE 2 ON/OFF** to activate ZONE 2.

The ZONE 2 indicator lights up.

- **When connecting the Zone 2 front speakers to the FRONT2/ZONE2 SPEAKERS terminals**, see also “Setting the Zone 2/Speakers 2 usage” on page 38, and “Activating the Zone 2 Front Speakers” on page 29.

### 3. Press **ZONE 2 CONTROL** so that “ZONE2” and the previously selected Zone 2 source name appear on the display.

“ZONE2” appears.

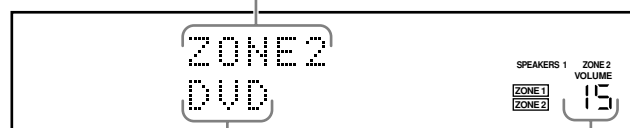

The last Zone 2 source appears.

The Zone 2 volume level appears.

Now the buttons and controls on the unit work for Zone 2 operations.

- Each time you press the button, the buttons and controls on the unit are activated or deactivated for Zone 2 operations alternately.

To turn off the power (into standby mode), press  $\odot$ /I STANDBY/ON again. The STANDBY lamp lights up.

**On the remote control:**

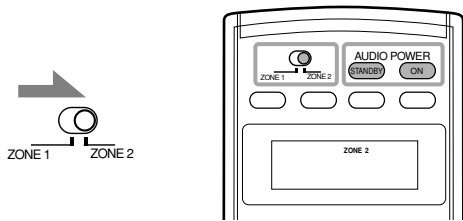

**1. Set ZONE 1/ZONE 2 selector to ZONE 2.**  
Now the buttons on the remote control work for Zone 2 operations.

**2. Press AUDIO POWER ON.**  
The STANDBY lamp goes off, and the ZONE 2 indicator lights up on the unit's display.

- When connecting the Zone 2 front speakers to the FRONT2/ZONE2 SPEAKERS terminal, see also "Setting the Zone 2/Speakers 2 usage" on page 38, and "Activating the Zone 2 Front Speakers" on page 29.

To turn off the power (into standby mode), press AUDIO POWER STANDBY. The STANDBY lamp lights up.

**Notes:**

- A small amount of power is consumed in standby mode. To turn the power off completely, unplug the AC power cord.
- If you have turned off the receiver with the volume level set at more than level "30," the volume level will be automatically set at level "30" next time you turn on the receiver.

**Canceling the Zone 2 Operations**

**On the front panel:**

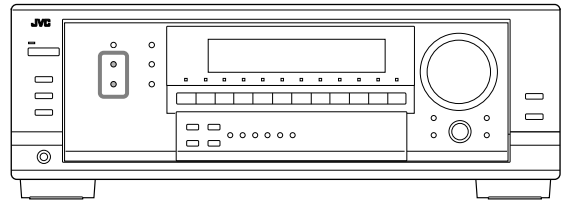

To stop Zone 2 operations and sounds from the Zone 2 speakers, press ZONE 2 ON/OFF so that the ZONE 2 indicator goes off from the display. No sound will be heard in Zone 2, and the display changes to show the Zone 1 source.

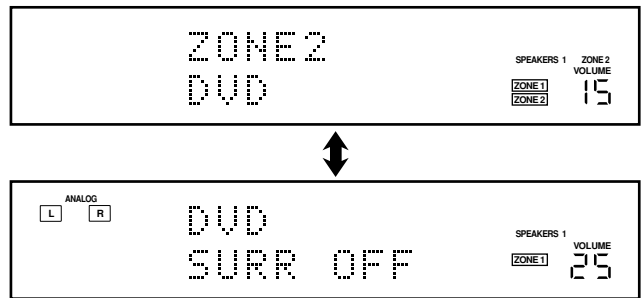

To use this receiver for Zone 2 operations again

1. Press ZONE 2 ON/OFF again so that the ZONE 2 indicator lights up on the display.
2. Press ZONE 2 CONTROL so that "ZONE2" and the previously selected Zone 2 source name appear on the display.

**On the remote control:**

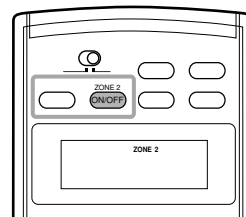

To stop Zone 2 operations and sounds from the Zone 2 speakers, press ZONE 2 ON/OFF so that the ZONE 2 indicator on the unit's display goes off.

To use this receiver for Zone 2 operations again, press ZONE 2 ON/OFF again (the ZONE 2 indicator lights up).

**Note:**

If "TURN ON ZONE1 OR ZONE2" appears on the unit's display, press ZONE 1 ON/OFF or ZONE 2 ON/OFF to listen to the sound in Zone 1 or in Zone 2; otherwise, the receiver will turn off after about 1 minute.

## Selecting the Zone 2 Source to Play

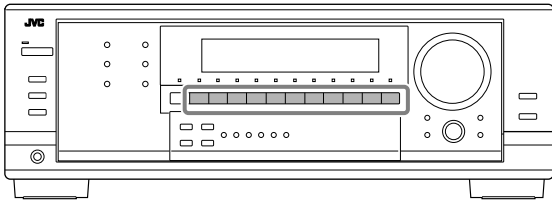

Press one of the source selection buttons (except DVD MULTI and TV SOUND).

Ex. When DVD is selected as the source.

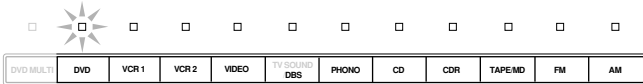
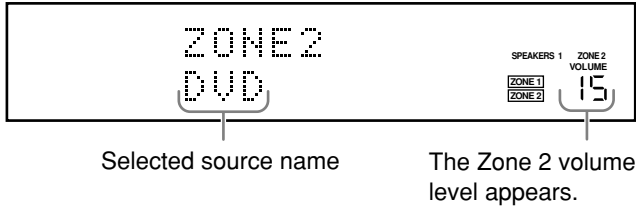

On the front panel

- The lamp on the selected source lights up (ex. when DVD is selected as the source).



On the remote

### Notes:

- When connecting an MD recorder (to the TAPE/MD IN jacks), and a DBS tuner (to the TV SOUND/DBS IN jacks), change the source names shown on the display. For details, see "Changing the Source Name" on page 24.
- When you press one of the audio source selection buttons (PHONO, CD, TAPE/MD, CDR, FM or AM) on the remote control, the receiver automatically turns on. If you turn on the receiver with the ZONE 1/ZONE 2 selector set to ZONE 1, press ZONE 2 ON/OFF to activate Zone 2 operations.
  - While Zone 2 is deactivated, press one of the audio source selection buttons on the remote control with the ZONE 1/ZONE 2 selector set to ZONE 2 to activate Zone 2 operations.
- You cannot select the following as a Zone 2 source:
  - "TV SOUND" and "DVD MULTI"
  - Any digital input

You can only select the analog input as the Zone 2 source. (If analog connections have not been made, no sound comes out of the Zone 2 speakers.)

## Adjusting the Zone 2 Volume

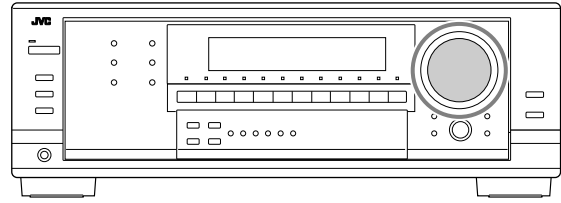

### On the front panel:

To increase the volume, turn MASTER VOLUME clockwise.  
To decrease the volume, turn it counterclockwise.

### On the remote control:

To increase the volume, press VOLUME +.  
To decrease the volume, press VOLUME -.

### Note:

The volume level can be adjusted within the range of "0" (minimum) to "70" (maximum).

### CAUTIONS:

- Always set the volume to the minimum before starting any source. If the volume is set at a high level, the sudden blast of sound energy can permanently damage your hearing and/or ruin your speakers.
- Be careful not to turn up the volume too high when controlling the receiver without listening to the playback sound. For example, when adjusting the volume level in Zone 2 from Zone 1.

## Activating the Zone 2 Front Speakers



The following operations are NOT applicable to those who connect the Zone 2 front speakers through the ZONE 2 PREOUT jacks through another amplifier (see page 16).

### Before you start, remember...

When shipped from the factory, both pairs of the front speakers have been set to be used in Zone 1.

- To use the speakers connected to the FRONT2/ZONE2 SPEAKERS terminals, set the speaker usage correctly. (See “Setting the Zone 2/Speakers 2 usage” on page 38.)

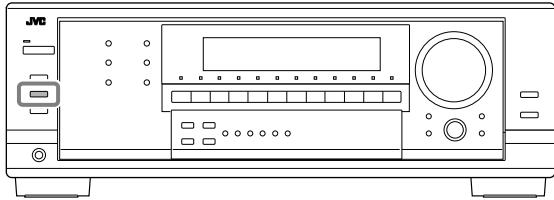

Press **SPEAKERS ON/OFF 2/ZONE 2** to activate the Zone 2 front speakers.

The SPEAKERS ZONE 2 indicator lights up on the display.

The SPEAKERS ZONE 2 indicator lights up.

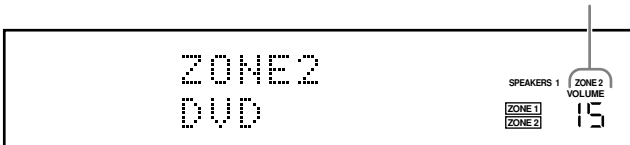

To deactivate the Zone 2 front speakers, press **SPEAKERS ON/OFF 2/ZONE 2** again.

The SPEAKERS ZONE 2 indicator goes off from the display.

### Note:

While the Zone 2 front speakers are activated, you can use only the front speakers (plus subwoofer) for the Surround/DSP modes in Zone 1. Then the 3D-PHONIC processing (see page 43) is applied to the Surround/DSP modes in Zone 1 (the 3D-PHONIC indicator lights up).

For those who connect the Zone 2 front speakers using the ZONE 2 PREOUT jacks through another amplifier (see page 16)

### To use the Zone 2 front speakers

1. Turn on the other amplifier connected to the ZONE 2 PREOUT jacks.
2. Adjust the volume level of the Zone 2 front speakers through this receiver.

### CAUTION:

Be sure to turn down the volume:  
Before turning on the speakers again, as its high volume may come out of the speakers.

## Muting the Zone 2 Sound

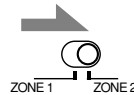

Set ZONE 1/ZONE 2 selector to ZONE 2.

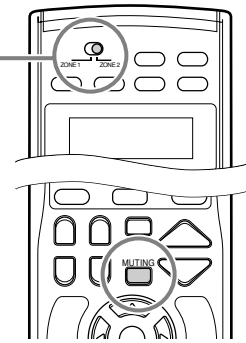

Press **MUTING** to mute the sound through the Zone 2 front speakers.

- The VOLUME level indicator goes off from the unit's display.

To restore the sound, press **MUTING** again so that the VOLUME level indicator appears on the unit's display.

- Turning **MASTER VOLUME** on the unit or pressing **VOLUME +/-** on the remote control also restores the sound.

# Receiving Radio Broadcasts

You can browse through all the stations or use the preset function to go immediately to a particular station.



Indicates the functions YOU CAN ALSO USE when the receiver is ready for Zone 2 operations.

## IMPORTANT:

Check the following before or while using the buttons and controls.

### For Zone 1 operations:

The ZONE 1 indicator lights up on the unit's display.

### For Zone 2 operations:

The ZONE 2 indicator lights up on the unit's display.

### When using the unit:

- For Zone 1 operations: "ZONE2" is not shown in the unit's main display.
- For Zone 2 operations: "ZONE2" is shown in the unit's main display.

### When using the remote control:

When operating the receiver using the remote control, the unit's display always shows the Zone 1 source information though you are operating it for the Zone 2 source.

- Set the ZONE 1/ZONE 2 selector to ZONE 1 or ZONE 2 correctly.
- Check the indication shown on the remote's display when you press a button—this indicates the remote control operation mode together with multi-room operation mode (either for ZONE 1 or ZONE 2) for about two hours.

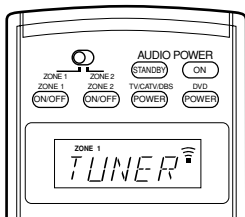
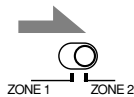
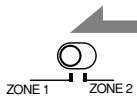

Ex. When you press FM or AM with ZONE 1/ZONE 2 selector set to ZONE 1.

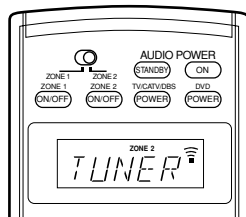

Ex. When you press FM or AM with ZONE 1/ZONE 2 selector set to ZONE 2.

## Tuning in to Stations Manually

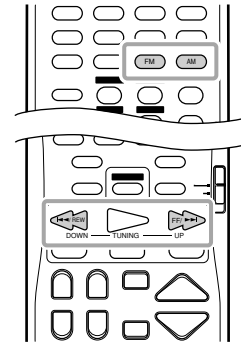
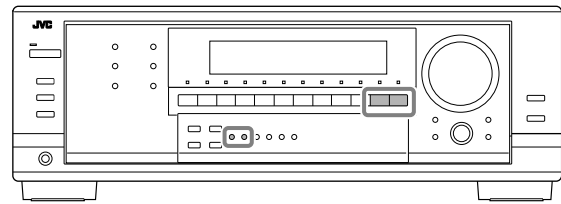

### 1. Press FM or AM to select the band.

The last received station of the selected band is tuned in.

When operating for Zone 1

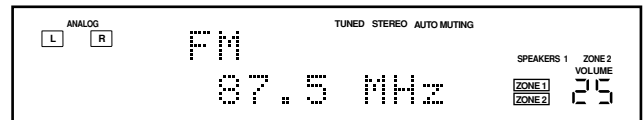

When operating for Zone 2

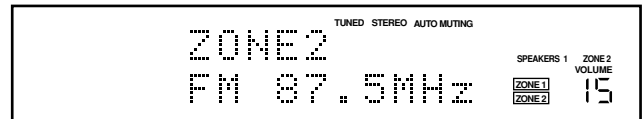

### 2. Tuning in to the frequency.

#### On the front panel:

Pressing FM/AM TUNING ▲ increases the frequency.  
Pressing FM/AM TUNING ▼ decreases the frequency.

#### On the remote control:

Pressing TUNING UP increases the frequency.  
Pressing TUNING DOWN decreases the frequency.

### Notes:

- When a station of sufficient signal strength is tuned in, the TUNED indicator lights up on the unit's display.
- When an FM stereo program is received, the STEREO indicator also lights up on the unit's display.
- When you hold the button (and release it) in step 2, the frequency keeps changing until a station is tuned in.
- You can only select the same station of the same band (FM or AM) for both Zone 1 and Zone 2 operations. If you change the station for Zone 2, it also changes for Zone 1 (and vice versa: indications on the unit's display also change). This also means that if you change the station for Zone 2 while recording a broadcasting program in Zone 1, recording in Zone 1 will be interrupted.



## Using Preset Tuning

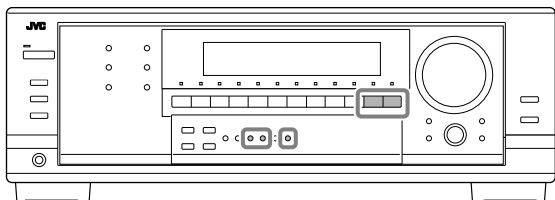

Once a station is assigned to a channel number, the station can be quickly tuned in. You can preset up to 30 FM and 15 AM stations.

### To store the preset stations



Before you start, remember...

There is a time limit in doing the following steps. If the setting is canceled before you finish, start from step 2 again.

1. Tune in to the station you want to preset (see “Tuning in to Stations Manually”).
  - If you want to store the FM reception mode for this station, select the FM reception mode you want. See “Selecting the FM Reception Mode” on the right column.
2. Press MEMORY.

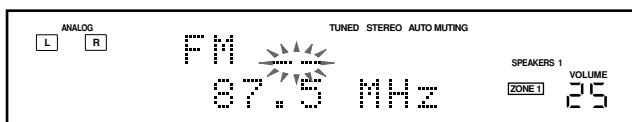

The channel number position starts flashing on the display for about 10 seconds.

3. Press FM/AM PRESET ▲ or ▼ to select a channel number while the channel number position is flashing.

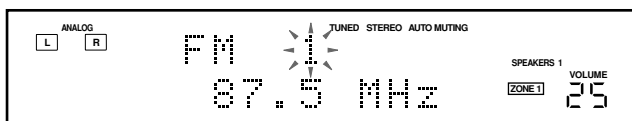

4. Press MEMORY again while the selected channel number is flashing on the display.

The selected channel number stops flashing.

The station is assigned to the selected channel number.

5. Repeat steps 1 to 4 until you store all the stations you want.

### To erase a stored preset station

Storing a new station on a used number erases the previously stored one.

### To tune in to a preset station



On the front panel:

1. Press FM or AM to select the band.
 

The last received station of the selected band is tuned in.
2. Press FM/AM PRESET ▲ or ▼ until you find the channel you want.

### On the remote control:

1. Press FM or AM to select the band.
 

The last received station of the selected band is tuned in.
2. Press the 10 keys to select a preset channel number.
  - For channel number 5, press 5.
  - For channel number 15, press +10 then 5.
  - For channel number 20, press +10 then 10.
  - For channel number 30, press +10, +10, then 10.

### Notes:

- You can only select the same station of the same band (FM or AM) for both Zone 1 and Zone 2 operations. If you change the station for Zone 1 (and vice versa: indications on the unit's display also change). This also means that if you change the station for Zone 2 while recording a broadcasting program in Zone 1, recording in Zone 1 will be interrupted.
- When the 10 keys do not work for selecting a preset channel number, press FM or AM on the remote control so that the remote control can be used for tuner operation.

## Selecting the FM Reception Mode

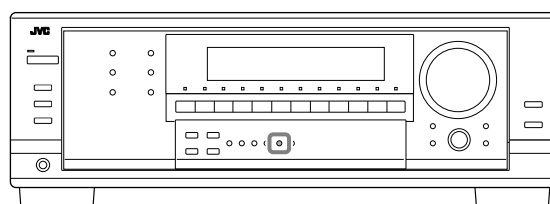

When an FM stereo broadcast is hard to receive or noisy, you can change the FM reception mode while receiving an FM broadcast.

- You can store the FM reception mode for each preset station.

### While listening to an FM station, press FM MODE.

- Each time you press the button, the FM reception mode alternates between “AUTOMUTING” and “MODE MONO.”

**AUTOMUTING** Normally select this.

When a program is broadcasted in stereo, you will hear stereo sound; when in monaural, you will hear monaural sounds.

This mode is also useful to suppress static noise between stations.

The AUTO MUTING indicator lights up on the display. (Initial setting)

**MODE MONO** Select this to improve the reception (but stereo effect will be lost).

In this mode, you will hear noise while tuning in to the stations.

The AUTO MUTING indicator (and the STEREO indicator) goes off from the display.

### Note:

When you use the FM MODE on the remote control, be sure that it is activated for the tuner, not for the DVD and others.

# Basic Settings

Some of the following settings are required after connecting and positioning your speakers while others will make operations easier. You can use QUICK SPEAKER SETUP to easily set up your speaker configuration.

**Basic setting operations are only possible while the receiver is ready for Zone 1 operations.**

## IMPORTANT:

Check the following before or while using the buttons and controls.

### For Zone 1 operations:

The ZONE 1 indicator lights up on the unit's display.

- **When using the unit:**

- “ZONE2” is not shown in the unit's main display.

## Quick Speaker Setup



Quick Speaker Setup helps you to easily and quickly register the speaker size and speaker distance according to your listening room to create the best possible surround effect.

- You can also register each speaker's information manually. For details, see page 34.

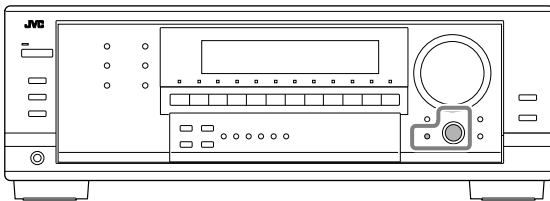

### Before you start, remember...

There is a time limit in doing the following steps. If the setting is canceled before you finish, start from step 1 again.

### 1. Press QUICK SPEAKER SETUP.

“SETUP” and “SPEAKERS?” appear on the display, then the initial setting for the total number of the connected speakers (channels) appears.

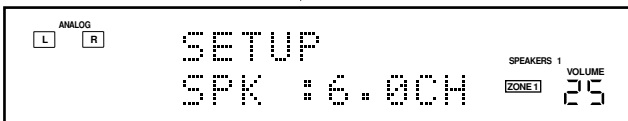

### 2. Turn MULTI JOG to select an appropriate number of the connected speakers (speaker channel number).

As you turn the jog, the speaker channel number changes as follows.

- For the details of speaker channel number, see “Speakers (channels) number and the size” on page 33.

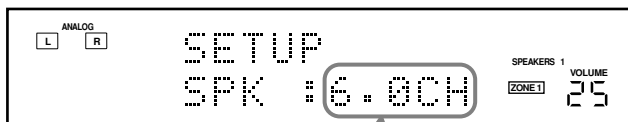

2.0CH ⇄ 2.1CH ⇄ 3.0CH ⇄ 3.1CH ⇄ 4.0CH ⇄ 4.1CH ⇄ 5.0CH ⇄ 5.1CH ⇄ **6.0CH\*** ⇄ 6.1CH ⇄ 7.0CH ⇄ 7.1CH ⇄ (Back to the beginning)

\* “6.0CH” is the initial setting.

### 3. Press in MULTI JOG (PUSH SET).

“ROOM SIZE?” appears on the display, then the initial room size setting appears.



### 4. Turn MULTI JOG to select an appropriate room size to match to your listening room.

As you turn the jog, the room size changes as follows.

- To select your appropriate room size, see “Room size and the speaker distance” on page 33.



SMALL ⇄ MID ⇄ **LARGE\*** ⇄ (Back to the beginning)

\* “LARGE” is the initial setting.

### 5. Press in MULTI JOG (PUSH SET).

“COMPLETE” appears on the display, then goes back to the source indication.

- Speaker configuration settings now become active.

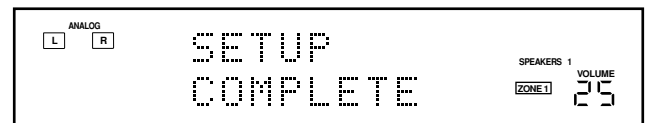

### Notes:

- This procedure will not be completed if you stop in the middle of the setting process.
- Once Quick Speaker Setup is performed, the speaker output levels are also set to appropriate values automatically (common to all sources). If you want to set the speaker output levels separately for each source, see “Adjusting the speaker output levels” on page 40.

### Speakers (channels) number and the size

You can find how each of the speaker size is defined according to the number of connected speakers (speaker channel "CH" number) you select.

- Subwoofer is counted as 0.1 channel.

CH	The size of connected speakers				
	L/R	C	LS/RS	SB	SUBWFR
2.0CH	LARGE	NONE	NONE	NONE	NO
2.1CH	SMALL	NONE	NONE	NONE	YES
3.0CH	LARGE	SMALL	NONE	NONE	NO
3.1CH	SMALL	SMALL	NONE	NONE	YES
4.0CH	LARGE	NONE	SMALL	NONE	NO
4.1CH	SMALL	NONE	SMALL	NONE	YES
5.0CH	LARGE	SMALL	SMALL	NONE	NO
5.1CH	SMALL	SMALL	SMALL	NONE	YES
6.0CH	LARGE	SMALL	SMALL	SMALL	NO
6.1CH	SMALL	SMALL	SMALL	SMALL	YES
7.0CH	LARGE	SMALL	SMALL	SMALL*	NO
7.1CH	SMALL	SMALL	SMALL	SMALL*	YES

\* This setting is applied to the both surround back speakers.

### Room size and the speaker distance

According to the selected room size, speaker distance for each activated speaker is set as follows:

Size	Speaker	Distance
<b>LARGE</b>	L/R	3.0 m (10 ft)
	C	3.0 m (10 ft)
	LS/RS	3.0 m (10 ft)
	SB	3.0 m (10 ft)
<b>MID</b>	L/R	2.7 m (9 ft)
	C	2.4 m (8 ft)
	LS/RS	2.1 m (7 ft)
	SB	1.8 m (6 ft)
<b>SMALL</b>	L/R	2.4 m (8 ft)
	C	2.1 m (7 ft)
	LS/RS	1.5 m (5 ft)
	SB	1.2 m (4 ft)

#### Note:

In the tables above, "L" stands for the left front speaker, "R" for the right front speaker, "C" for the center speaker, "LS" for the left surround speaker, "RS" for the right surround speaker, "SB" for the surround back speaker, and "SUBWFR" for the subwoofer.

## Basic Setting Items



On the following pages, you can adjust the following items:

- You can only select the items currently available. For details, see the explanation of each item.

Items	To do	See page
<b>SUB WOOFER*</b>	Register your subwoofer.	34
<b>FRONT SPEAKER*</b>	Register your front speaker size.	34
<b>CNTR SPEAKER*</b>	Register your center speaker size.	34
<b>SURR SPEAKER*</b>	Register your surround speaker size.	34
<b>SBACK SPEAKER*</b>	Register your surround back speaker size.	34
<b>SBACK OUT*</b>	Register the number of the connected surround back speakers.	34
<b>DIST UNIT</b>	Select the measuring unit for the speaker distance.	35
<b>FRNTL DISTANCE*</b>	Register the distance from the left front speaker to your listening point.	35
<b>FRNTR DISTANCE*</b>	Register the distance from the right front speaker to your listening point.	35
<b>CNTR DISTANCE*</b>	Register the distance from the center speaker to your listening point.	35
<b>SURRL DISTANCE*</b>	Register the distance from the left surround speaker to your listening point.	35
<b>SURRR DISTANCE*</b>	Register the distance from the right surround speaker to your listening point.	35
<b>SBACK DISTANCE*</b>	Register the distance from the surround back speaker(s) to your listening point.	35
<b>S WFR OUTPUT</b>	Select sounds emitted from the subwoofer.	35
<b>CROSS OVER</b>	Select the cutoff frequency to the subwoofer.	36
<b>LFE ATTENUATE</b>	Attenuate the bass (LFE) sounds.	36
<b>DUAL MONO</b>	Select the Dual Mono sound channel.	36
<b>DGTL IN COAX</b>	Select the component connected to digital coaxial terminal.	37
<b>DGTL IN OPTICAL</b>	Select the components connected to digital optical terminals.	37
<b>VIDEO IN DVD</b>	Select the type of video terminal used for the DVD player.	38
<b>VIDEO IN DBS</b>	Select the type of video terminal used for the DBS tuner.	38
<b>VIDEO IN VCR1</b>	Select the type of video terminal used for the VCR 1.	38
<b>FRONT SPEAKER2</b>	Set the Zone 2/Speakers 2 usage.	38
<b>ONE TOUCH OPE</b>	Store the volume level for each source.	38

#### Note:

\* These items can be set using Quick Speaker Setup.

## Basic Procedure

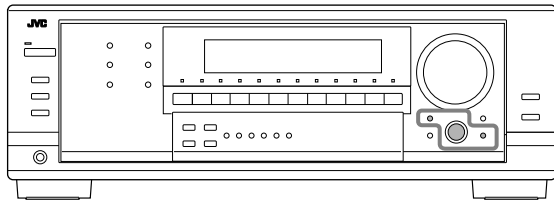

### Before you start, remember...

There is a time limit in doing the following steps. If the setting is canceled before you finish, start from step 1 again.

Ex. When setting One Touch Operation to “ON.”

#### 1. Press SETTING.

The last selected item appears on the display.



#### 2. Turn MULTI JOG until an item you want appears on the display.

In this example, select “ONE TOUCH OPE.” For available items, see the list “Basic Setting Items” on page 33.



#### 3. Push in MULTI JOG (PUSH SET).

The current setting for the selected item appears on the display.



#### 4. Turn MULTI JOG until a setting you want appears on the display.

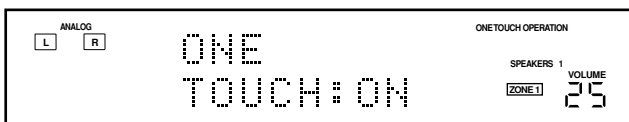

#### 5. Push in MULTI JOG (PUSH SET).

#### 6. Repeat steps 2 to 5 to set other items if necessary.

#### 7. Press EXIT.

The source indication resumes on the display.

: shows the initial setting in the following tables.

## Setting the speakers

To obtain the best possible surround effect from the Surround and DSP modes in Zone 1, register the setting about the speaker arrangement after all connections are completed.

- If you have used Quick Speaker Setup on page 32, this setting is not required.

### ■ Subwoofer setting—SUB WOOFER

Select whether you have connected a subwoofer or not.

**SUB WOOFER: YES** Select when a subwoofer is connected.

**SUB WOOFER: NO** Select when no subwoofer is used.

#### Note:

If you have selected “SUB WOOFER: NO,” you cannot use the SUBWOOFER OUT ON/OFF button.

### ■ Speaker size—FRONT SPEAKER, CNTR SPEAKER, SURR SPEAKER, SBACK SPEAKER

Select the size for each connected speaker.

**LARGE\*<sup>1</sup>** Select when the speaker size is relatively large.

**SMALL\*<sup>2</sup>** Select when the speaker size is relatively small.

**NONE** Select this when you have not connected a speaker. (Not selectable for the front speakers.)

\*<sup>1</sup> Initial setting for front speakers.

\*<sup>2</sup> Initial setting for center, surround, and surround back speakers.

#### Notes:

- Keep the following comments in mind as reference when adjusting.
  - If the size of the cone speaker unit built in your speaker is larger than 12 cm (4 3/4 inches), select “LARGE,” and if it is smaller than 12 cm (4 3/4 inches), select “SMALL.”
- If you have selected “SUB WOOFER: NO,” you can only select “LARGE” for the front speakers.
- If you have selected “SMALL” for the front speakers, you cannot select “LARGE” for the center, surround, and surround back speakers.
- If you have selected “SMALL” for the surround speakers, you cannot select “LARGE” for the surround back speakers.
- If you have selected “NONE” for the surround speakers, the surround back speakers are fixed to “NONE.”

### ■ Surround back speakers quantity—SBACK OUT

Select the number of the surround back speakers connected.

**SBACK OUT: 1SPK** Select to use 1 surround back speaker.

**SBACK OUT: 2SPK** Select to use 2 surround back speakers.

#### Note:

If you have selected “NONE” for the surround back speakers (see above), this setting is not available.

## Setting the speaker distance

The distance from your listening point to the speakers is another important element to obtain the best possible sound of the Surround and DSP modes. Set the distance from your listening point to the speakers.

By referring to the speaker distance setting, this unit automatically sets the delay time of the sound through each speaker so that sounds through all the speakers can reach you at the same time.

- If you have used Quick Speaker Setup on page 32, this setting is not required.

### ■ Measuring unit—DIST UNIT

Select which measuring unit you use.

**DIST UNIT: meter** Select to set the distance in meters.

**DIST UNIT: feet** Select to set the distance in feet.

### ■ Speaker distance—FRNTL DISTANCE, FRNTR DISTANCE, CNTR DISTANCE, SURRL DISTANCE, SURRR DISTANCE, SBACK DISTANCE

Set the distance from the listening point within the range of 0.3 m (1 ft) to 9.0 m (30 ft), in 0.3 m (1 ft) intervals.

- When shipped from the factory, distance for each speaker is set to “3.0 m (10 ft).”

#### Notes:

- You cannot set the speaker distance for the speakers you have selected “NONE” (see page 34).
- This setting is not valid for the DVD MULTI playback mode.

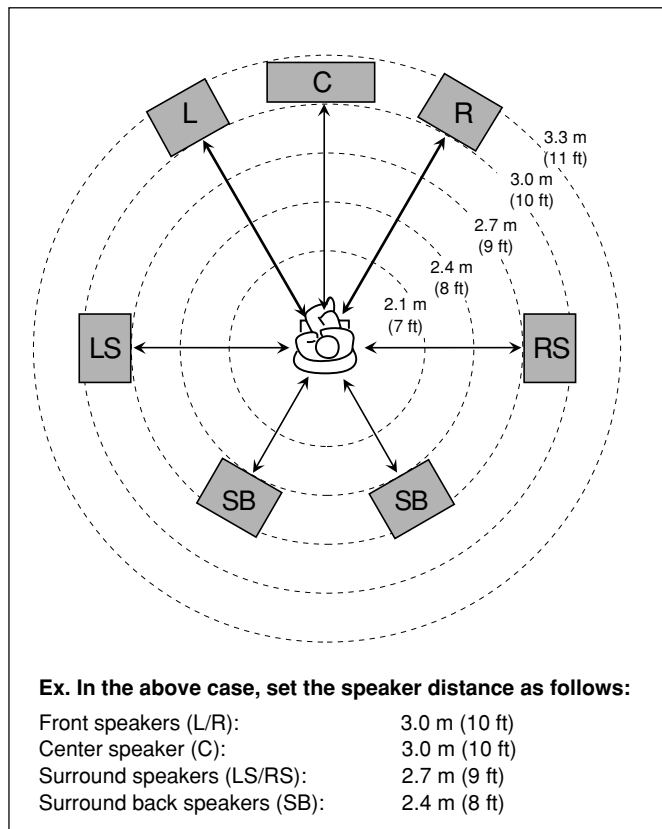

## Setting the bass sounds

You can adjust subwoofer and bass sounds precisely according to your preference.

### ■ Subwoofer output—S WFR OUTPUT

You can select the type of the signal which can be transmitted through the subwoofer. In other words, you can determine whether or not the bass elements of the front speaker channels are transmitted through the subwoofer regardless of the front speaker size setting (either “SMALL” or “LARGE”).

Select one of the following:

**S WFR: LFE** Select to emit only the LFE signals (while playing Dolby Digital or DTS software) or the bass elements of the “SMALL” front speakers (while playing any source other than the above).

#### **S WFR: LFE+MAIN**

Select to always emit the bass elements of the front speaker channels (MAIN). While playing Dolby Digital or DTS software, the bass element and the LFE signals are both emitted.

#### Note:

If you have selected “SUB WOOFER: NO,” this function is not available.

■ **Crossover frequency—CROSS OVER**

You can select the crossover frequency for the small speakers used. The signals below the selected frequency level will be sent to and be reproduced by the subwoofer (or by “LARGE” speakers when you have selected “SUB WOOFER: NO”).

Select one of the crossover frequency levels according to the size of the small speaker connected.

**CROSS OVER: 80Hz**

Select when the cone speaker unit built in the speaker is about 12 cm (4 3/4 inches).

**CROSS OVER: 100Hz**

Select when the cone speaker unit built in the speaker is about 10 cm (3 15/16 inches).

**CROSS OVER: 120Hz**

Select when the cone speaker unit built in the speaker is about 8 cm (3 1/16 inches).

**CROSS OVER: 150Hz**

Select when the cone speaker unit built in the speaker is about 6 cm (2 3/8 inches).

**CROSS OVER: 200Hz**

Select when the cone speaker unit built in the speaker is about 5 cm (2 inches).

**Notes:**

- If you have selected “LARGE” for all activated speakers (see page 34), this function is fixed to “OFF.”
- Crossover frequency is not valid for the DVD MULTI playback, Headphone, and 3D Headphone mode.

■ **Low frequency effect attenuator—LFE ATTENUATE**

If the bass sound is distorted while playing back software encoded with Dolby Digital or DTS, set the LFE level to eliminate distortion.

- This function takes effect only when the LFE signals come in.

Select one of the following:

**LFE ATT: 0dB** Normally select this.

**LFE ATT: -10dB** Select when the bass sound is distorted.

**Selecting the main or sub-channel**

You can select the playback sound (channel) you want while playing digital software recorded (or broadcast) in the Dual Mono mode (see page 43), which includes two monaural channels separately.

■ **Dual Mono—DUAL MONO**

Select the playback sounds (channel).

**DUAL MONO: MAIN**

Select to play back the main channel (Ch 1).\*  
The signal indicator “L” lights up while playing back this channel.

**DUAL MONO: SUB**

Select to play back the sub-channel (Ch 2).\*  
The signal indicator “R” lights up while playing back this channel.

**DUAL MONO: ALL**

Select to play back both the main and sub-channels (Ch 1/Ch 2).\*  
The signal indicators “L” and “R” light up while playing back these channels.

**Notes:**

- The Dual Mono format is not identical with bilingual broadcasting or the MTS (Multichannel Television Sound) format used for TV programs. So this setting does not take effect while watching bilingual or MTS programs.
- \* Dual Mono signals can be heard from the following speakers—L (left front speaker), R (right front speaker), and C (center speaker)—with respect to the current Surround setting.

Dual Mono Setting	Without Surround		With Surround Activated				
			Center speaker setting				
	L	R	SMALL/LARGE		NONE		
	L	R	L	C	R	L	R
<b>MAIN</b>	Ch 1	Ch 1	—	Ch 1	—	Ch 1	Ch 1
<b>SUB</b>	Ch 2	Ch 2	—	Ch 2	—	Ch 2	Ch 2
<b>ALL</b>	Ch 1	Ch 2	—	Ch 1+Ch 2	—	Ch 1+Ch 2	Ch 1+Ch 2

## Setting the digital input terminals

When you use the digital input terminals, register which components you have connected to the digital input terminals.

### ■ Digital coaxial terminal—DGTL IN COAX

Set the component connected to the digital coaxial terminal (DIGITAL 1).

Following setting is available:

- DVD (initial setting)
- CD
- TV (or DBS\*1)
- CDR
- MD
- VCR\*2

### ■ Digital optical terminals—DGTL IN OPTICAL

Set the components connected to the digital optical terminals (DIGITAL 2 – 4).

- As you turn MULTI JOG, the digital optical input terminals are set to used for following digital components:

When “DIGITAL 1 (DGTL IN COAX)” is set to “DVD”:

2: CD	3: TV (or DBS*1)	4: CDR	⇐⇐
2: CD	3: TV (or DBS*1)	4: MD	⇐⇐
2: CD	3: TV (or DBS*1)	4: VCR*2	⇐⇐
2: CD	3: MD	4: CDR	⇐⇐
2: CD	3: MD	4: VCR*2	⇐⇐
2: CD	3: VCR*2	4: CDR	⇐⇐
2: MD	3: TV (or DBS*1)	4: CDR	⇐⇐
2: MD	3: TV (or DBS*1)	4: VCR*2	⇐⇐
2: MD	3: VCR*2	4: CDR	⇐⇐
2: VCR*2	3: TV (or DBS*1)	4: CDR	⇐⇐
(back to the beginning)			

When “DIGITAL 1 (DGTL IN COAX)” is set to “CD”:

2: DVD	3: TV (or DBS*1)	4: CDR	⇐⇐
2: DVD	3: TV (or DBS*1)	4: MD	⇐⇐
2: DVD	3: TV (or DBS*1)	4: VCR*2	⇐⇐
2: DVD	3: MD	4: CDR	⇐⇐
2: DVD	3: MD	4: VCR*2	⇐⇐
2: DVD	3: VCR*2	4: CDR	⇐⇐
2: MD	3: TV (or DBS*1)	4: CDR	⇐⇐
2: MD	3: TV (or DBS*1)	4: VCR*2	⇐⇐
2: MD	3: VCR*2	4: CDR	⇐⇐
2: VCR*2	3: TV (or DBS*1)	4: CDR	⇐⇐
(back to the beginning)			

When “DIGITAL 1 (DGTL IN COAX)” is set to “TV” or “DBS”\*1:

2: CD	3: DVD	4: CDR	⇐⇐
2: CD	3: DVD	4: MD	⇐⇐
2: CD	3: DVD	4: VCR*2	⇐⇐
2: CD	3: MD	4: CDR	⇐⇐
2: CD	3: MD	4: VCR*2	⇐⇐
2: CD	3: VCR*2	4: CDR	⇐⇐
2: MD	3: DVD	4: CDR	⇐⇐
2: MD	3: DVD	4: VCR*2	⇐⇐
2: MD	3: VCR*2	4: CDR	⇐⇐
2: VCR*2	3: DVD	4: CDR	⇐⇐
(back to the beginning)			

When “DIGITAL 1 (DGTL IN COAX)” is set to “CDR”:

2: CD	3: TV (or DBS*1)	4: DVD	⇐⇐
2: CD	3: TV (or DBS*1)	4: MD	⇐⇐
2: CD	3: TV (or DBS*1)	4: VCR*2	⇐⇐
2: CD	3: MD	4: DVD	⇐⇐
2: CD	3: MD	4: VCR*2	⇐⇐
2: CD	3: VCR*2	4: DVD	⇐⇐
2: MD	3: TV (or DBS*1)	4: DVD	⇐⇐
2: MD	3: TV (or DBS*1)	4: VCR*2	⇐⇐
2: MD	3: VCR*2	4: DVD	⇐⇐
2: VCR*2	3: TV (or DBS*1)	4: DVD	⇐⇐
(back to the beginning)			

When “DIGITAL 1 (DGTL IN COAX)” is set to “MD”:

2: CD	3: TV (or DBS*1)	4: CDR	⇐⇐
2: CD	3: TV (or DBS*1)	4: DVD	⇐⇐
2: CD	3: TV (or DBS*1)	4: VCR*2	⇐⇐
2: CD	3: DVD	4: CDR	⇐⇐
2: CD	3: DVD	4: VCR*2	⇐⇐
2: CD	3: VCR*2	4: CDR	⇐⇐
2: DVD	3: TV (or DBS*1)	4: CDR	⇐⇐
2: DVD	3: TV (or DBS*1)	4: VCR*2	⇐⇐
2: DVD	3: VCR*2	4: CDR	⇐⇐
2: VCR*2	3: TV (or DBS*1)	4: CDR	⇐⇐
(back to the beginning)			

When “DIGITAL 1 (DGTL IN COAX)” is set to “VCR”\*2:

2: CD	3: TV (or DBS*1)	4: CDR	⇐⇐
2: CD	3: TV (or DBS*1)	4: MD	⇐⇐
2: CD	3: TV (or DBS*1)	4: DVD	⇐⇐
2: CD	3: MD	4: CDR	⇐⇐
2: CD	3: MD	4: DVD	⇐⇐
2: CD	3: DVD	4: CDR	⇐⇐
2: MD	3: TV (or DBS*1)	4: CDR	⇐⇐
2: MD	3: TV (or DBS*1)	4: DVD	⇐⇐
2: MD	3: DVD	4: CDR	⇐⇐
2: DVD	3: TV (or DBS*1)	4: CDR	⇐⇐
(back to the beginning)			

\*1 If you have changed the source name from “TV” to “DBS,” “DBS” appears (see page 24).

\*2 “VCR” on the DGTL IN COAX and DGTL IN OPTICAL setting menu means VCR1.

## Setting the component video input

When you use the component video inputs for connecting the DVD player and/or DBS tuner (or VCR), register the type of input jacks. If you have not selected appropriate video input jacks, the AV COMPU LINK remote control system cannot operate properly (See page 53) and you cannot see playback picture of those video components.

### ■ For the DVD player—VIDEO IN DVD

Select one of the following:

**VIDEO DVD: CMPNT** Select when connecting the DVD player to the component video input jacks.

**VIDEO DVD: S/C** Select when connecting the DVD player to the composite video or S-video input jacks.

### ■ For the DBS tuner—VIDEO IN DBS

Select one of the following:

**VIDEO DBS: CMPNT\*1** Select when connecting the DBS tuner to the component video input jacks.

**VIDEO DBS: S/C** Select when connecting the DBS tuner to the composite video or S-video input jacks.

#### Note:

\*1 When you have selected this setting, you cannot select "VIDEO VCR1: CMPNT" for "VIDEO IN VCR1." Then "VIDEO VCR1: S/C" is applied for "VIDEO IN VCR1" setting.

### ■ For the VCR—VIDEO IN VCR1

Select one of the following:

**VIDEO VCR1: CMPNT\*2** Select when connecting the VCR 1 to the component video input jacks.

**VIDEO VCR1: S/C** Select when connecting the VCR 1 to the composite video or S-video input jacks.

#### Note:

\*2 When you have selected this setting, you cannot select "VIDEO DBS: CMPNT" for "VIDEO IN DBS." Then "VIDEO DBS: S/C" is applied for "VIDEO IN DBS" setting.

## Setting the Zone 2/Speakers 2

You can select the usage of the speaker connected to the FRONT2/ZONE2 SPEAKERS terminals.

### ■ FRONT2/ZONE2 SPEAKERS terminal usage —FRONT SPEAKER2

Select one of the following:

**FRONT SPK2: SPK2** Select when connecting the second Zone 1 front speakers.

**FRONT SPK2: ZONE2** Select when connecting the Zone 2 front speakers.

#### Note:

When connecting the Zone 2 front speakers to the ZONE 2 PREOUT jacks through another amplifier (see "Connection [A]" on page 16), no settings are required on this receiver.

## Memorizing the volume level for each source

This unit memorizes some settings separately for each source (see page 25).

In addition, you can store the volume level for each source with the other memorized settings—One Touch Operation.

- This receiver memorizes the volume level—
  - when you turn off the power,
  - when you change the source,
  - when you press ZONE 1 ON/OFF or ZONE 2 CONTROL, and
  - when you change the source name.

### ■ One Touch Operation—ONE TOUCH OPE

Select one of the following:

**ONE TOUCH: ON** Select to store the volume level separately for each source. (The ONE TOUCH OPERATION indicator lights up on the display.)

**ONE TOUCH: OFF** Select this not to store the volume level.

#### To recall the volume level

With the ONE TOUCH OPERATION indicator lit, the volume level for the currently selected source is recalled when the source is selected.

#### To cancel the One Touch Operation

Set One Touch Operation to "ONE TOUCH: OFF" so that the ONE TOUCH OPERATION indicator goes off from the display.

#### Note:

If you have turned off the receiver with the volume level set at more than level "30," the volume level will be automatically set at level "30" next time you turn on the receiver.



# Adjusting Sound

You can make sound adjustment to your preference after completing basic setting.

**Sound adjustment operations are only possible while the receiver is ready for Zone 1 operations.**

## IMPORTANT:

Check the following before or while using the buttons and controls.

### For Zone 1 operations:

The ZONE 1 indicator lights up on the unit's display.

- **When using the unit:**
  - “ZONE2” is not shown in the unit's main display.
- **When using the remote control:**
  - Set the ZONE 1/ZONE 2 selector to **ZONE 1**.
  - Check the indication shown on the remote's display when you press a button—this indicates the remote control operation mode together with multi-room operation mode (either for ZONE 1 or ZONE 2) for about two hours.

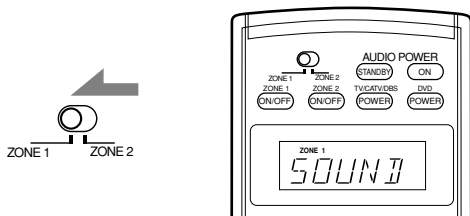

Ex. When you press SOUND with ZONE 1/ZONE 2 selector set to ZONE 1.

## Basic Adjustment Items

On the following pages, you can adjust the items listed below:

- You can adjust only the items applicable to the current sound mode.
- **If Analog Direct is in use, you cannot make any sound adjustments except for “SUBWFR LVL.”**

Items	To do	See page
EQ 63Hz	Adjust equalizer pattern at 63 Hz.	40
EQ250Hz	Adjust equalizer pattern at 250 Hz.	40
EQ 1kHz	Adjust equalizer pattern at 1 kHz.	40
EQ 4kHz	Adjust equalizer pattern at 4 kHz.	40
EQ16kHz	Adjust equalizer pattern at 16 kHz.	40
SUBWFR LVL	Adjust the subwoofer output level.	40
FRNT L LVL	Adjust the left front speaker output level.	40
FRNT R LVL	Adjust the right front speaker output level.	40
CENTER LVL	Adjust the center speaker output level.	40
SURR L LVL	Adjust the left surround speaker output level.	40
SURR R LVL	Adjust the right surround speaker output level.	40
SBACK LVL	Adjust the surround back speaker(s) output level.	40
EFFECT* <sup>1</sup>	Adjust the effect level.	41
ROOMSIZE* <sup>1</sup>	Select the room size for your virtual listening room.	41
LIVENESS* <sup>1</sup>	Select the liveness level for your virtual listening room.	41
CTR TONE* <sup>2</sup>	Make the center tone soft or sharp.	41
PNRM CNTRL* <sup>3</sup>	Add “wraparound” sound effect with side-wall image.	41
CNTR WIDTH* <sup>2,3</sup>	Adjust the center channel localization between the center speaker and the left/right front speakers.	41
DIMENSION* <sup>3</sup>	Adjust sound localization position.	41
CNTR GAIN* <sup>2,4</sup>	Adjust sound localization of the center channel.	41

### Notes:

\*<sup>1</sup> Adjustable when one of the DAP modes or Mono Film (see pages 48 and 49) is in use.

\*<sup>2</sup> Cannot be adjust when center speaker is set to “NONE” (see page 34).

\*<sup>3</sup> Adjustable when Pro Logic IIx Music or Pro Logic II Music (see page 42) is in use.

\*<sup>4</sup> Adjustable when Neo:6 Music (see page 43) is in use.

## Basic Procedure

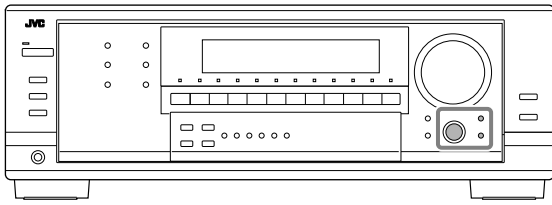

### Before you start, remember...

There is a time limit in doing the following steps. If the setting is canceled before you finish, start from step 1 again.

Ex. When adjusting the subwoofer level to “-3.”

#### 1. Press ADJUST.

The last selected item appears on the display.

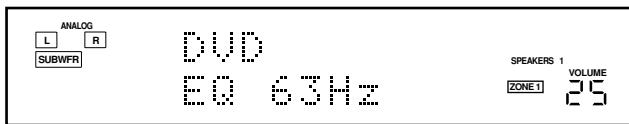

#### 2. Turn MULTI JOG until an item you want appears on the display.

- In this example, select “SUBWFR LVL.” For available items, see the list “Basic Adjustment Items” on page 39.



#### 3. Press in MULTI JOG (PUSH SET).

The current setting (or level) for the selected item appears on the display.



#### 4. Turn MULTI JOG to select a setting you want or to make an adjustment as you like.



#### 5. Press in MULTI JOG (PUSH SET).

#### 6. Repeat steps 2 to 5 to set other items if necessary.

#### 7. Press EXIT.

The source indication resumes on the display.

## Adjusting the equalization patterns

You can adjust the equalization patterns to your preference.

- Once you have made an adjustment, it is memorized for each source.
- The equalization pattern affects the front speaker sounds only.

### ■ Equalization adjustment—EQ 63Hz, EQ250Hz, EQ 1kHz, EQ 4kHz, EQ16kHz

You can adjust five frequencies (**63 Hz, 250 Hz, 1 kHz, 4 kHz, 16 kHz**) within the range of **-8 dB** to **+8 dB** (“0 (dB)” is the initial setting) in 2 dB steps.

- When an adjustment is made, the D.EQ indicator lights up on the display.

**To flat the equalization pattern**, set all the frequencies to “0 (dB)” in step 4 of “Basic Procedure” on the left column.

The D.EQ indicator goes off from the display.

### Note:

When Analog Direct is in use, Equalization patterns are not available.

## Adjusting the speaker output levels

You can adjust the speaker output levels.

- Once you have made an adjustment, it is memorized for each source.

### ■ Adjustable speakers

You can adjust the following speakers’ output levels within the range of **-10 dB** to **+10 dB** (“0 (dB)” is the initial setting):

<b>SUBWFR LVL</b>	Select to adjust the subwoofer output level.
<b>FRNT L LVL</b>	Select to adjust the left front speaker output level.
<b>FRNT R LVL</b>	Select to adjust the right front speaker output level.
<b>CENTER LVL</b>	Select to adjust the center speaker output level.
<b>SURR L LVL</b>	Select to adjust the left surround speaker output level.
<b>SURR R LVL</b>	Select to adjust the right surround speaker output level.
<b>SBACK LVL</b>	Select to adjust the surround back speaker output level.

### Notes:

- If you have selected “NO” or “NONE” for a speaker (see page 34), the output level for the corresponding speaker is not adjustable.
- Speaker output levels (except the subwoofer output level) are not adjustable when Analog Direct is in use. But when you canceled the subwoofer output using the SUBWOOFER OUT ON/OFF button (see page 22), you also cannot adjust the subwoofer output level.

## Adjusting the sound parameters for the Surround and DSP modes

You can adjust the Surround and DSP sound parameters to your preference. (For Surround and DSP modes, see pages 42 to 49.)

### ■ Adjustable parameters

You can adjust the following parameters:

#### For Surround and DSP modes (when the center speaker is connected)

- This setting is common to all Surround modes, and is memorized separately for DSP modes.

<b>CTR TONE</b>	Adjust the center tone. As the number increases, the dialogue becomes clearer so that the human voices change from soft to sharp. (Adjustable range: <b>1 to 5</b> . “3” is the initial setting, and normally select this.)
-----------------	--

#### For DAP modes and Mono Film

- Once you have made an adjustment, it is memorized for each mode.

<b>EFFECT</b>	Adjust the effect level. As the number increases, the effect becomes stronger. (Adjustable range: <b>1 to 5</b> . “3” is the initial setting, and normally select this.)
---------------	---

<b>ROOMSIZE</b>	Adjust the virtual room size. As the number increases, the interval between reflections increases so that you will feel as if you were in a larger room. (Adjustable range: <b>1 to 5</b> . “3” is the initial setting, and normally select this.)
-----------------	---

<b>LIVENESS</b>	Adjust the liveness effect. As the number increases, the attenuation level of reflections over time decreases so that acoustics change from “Dead” to “Live.” (Adjustable range: <b>1 to 5</b> . “3” is the initial setting, and normally select this.)
-----------------	--

#### For Pro Logic IIx Music and Pro Logic II Music

<b>PNRM CNTRL</b>	Select “ON” to add “wraparound” sound effect with side-wall image. (Initial setting: “OFF.”)
-------------------	--

<b>CNTR WIDTH</b>	Adjust the center channel localization between the center speaker and the left/right front speakers. As the number increases, the center channel sound moves toward the left and right speakers. (Adjustable range: <b>OFF</b> and <b>1 to 7</b> . “3” is the initial setting, and normally select this.)
-------------------	---

<b>DIMENSION</b>	Adjust the sound localization position. As the number increases, the sound localization moves towards forward from backward. (Adjustable range: <b>1 to 7</b> . “4” is the initial setting, and normally select this.)
------------------	--

#### For Neo:6 Music only

<b>CNTR GAIN</b>	Adjust the sound localization of the center channel. As the number increases, center channel will be localized clearly. (Adjustable range: <b>0 to 1.0</b> . “0.3” is the initial setting, and normally select this.)
------------------	--

You can also use the remote control for adjusting the speaker output level and DSP (DAP modes and Mono Film) effect levels (“EFFECT” and “LIVENESS”).

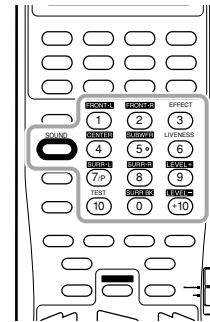

#### To adjust the speaker output level:

##### 1. Press SOUND.

The 10 keys are activated for sound adjustments.

##### 2. Press TEST to check if you can hear the sounds through all the speakers at equal level.

Test tone comes out of the speakers in the following order.

- No test tone comes out of the speakers for which the speaker setting is set to “NONE” (or “NO” for the subwoofer).
- While Zone 2 speakers are activated, no test tone comes out from center, surround, and surround back speakers.

*FRNT L (Left front speaker) → CENTER (Center speaker) → FRNT R (Right front speaker) → SURR R (Right surround speaker) → SBACK (Surround back speaker) → SURR L (Left surround speaker) → SUBWFR (Subwoofer) → (Back to the beginning)*

##### 3. Select the speaker you want to adjust.

- To select the left front speaker, press FRONT•L.
- To select the center speaker, press CENTER.
- To select the right front speaker, press FRONT•R.
- To select the right surround speaker, press SURR•R.
- To select the surround back speaker, press SURR BK.
- To select the left surround speaker, press SURR•L.
- To select the subwoofer, press SUBWFR.

The selected speaker name appears on the remote’s display for a while.

##### 4. Press LEVEL +/- to adjust the speaker output levels.

##### Notes:

- When you press each button once, the current level for the selected speaker appears on the unit’s display, and the test tone comes out of the selected speaker.
- If no adjustment is done for about 4 seconds, the adjustment mode for the selected speaker is canceled.

##### 5. Repeat steps 3 and 4 to adjust the other speaker output levels.

##### 6. Press TEST again to stop the test tone.

#### To adjust the DSP effect levels:

##### 1. Press SOUND.

The 10 keys are activated for sound adjustments.

##### 2. Press EFFECT repeatedly to adjust the effect level.

##### 3. Press LIVENESS repeatedly to adjust the liveness effect.

# Using the Surround Modes

This unit can activate a variety of Surround modes. The basic settings and adjustments stored (see pages 32 to 41) are applied.

- The following operations are only possible when the receiver is ready for Zone 1 operations, and are used only for Zone 1 sources.

## Reproducing Theater Ambience

In a movie theater, many speakers are located on the walls to reproduce impressive multi-surround sounds, reaching you from all directions.

With these many speakers, sound localization and sound movement can be expressed.

Surround modes built in this receiver can create almost the same surround sounds as you can feel in a real movie theater—with only five to seven speakers (plus subwoofer).

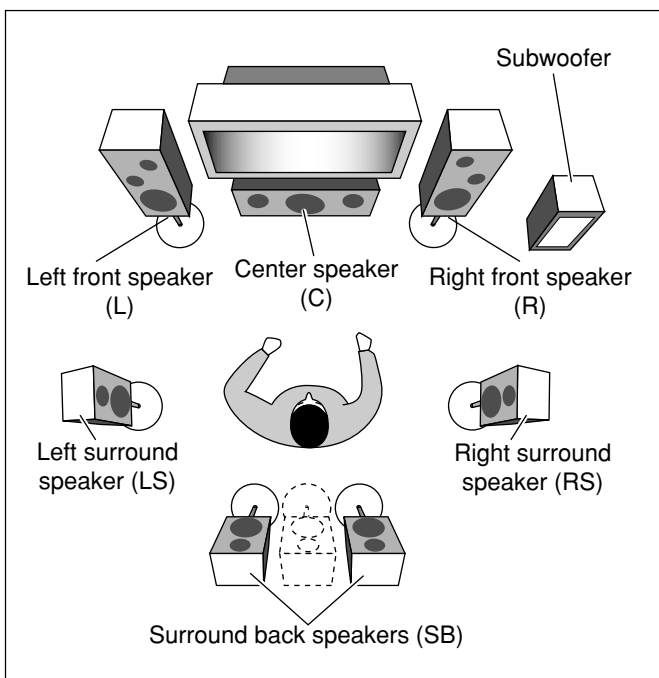
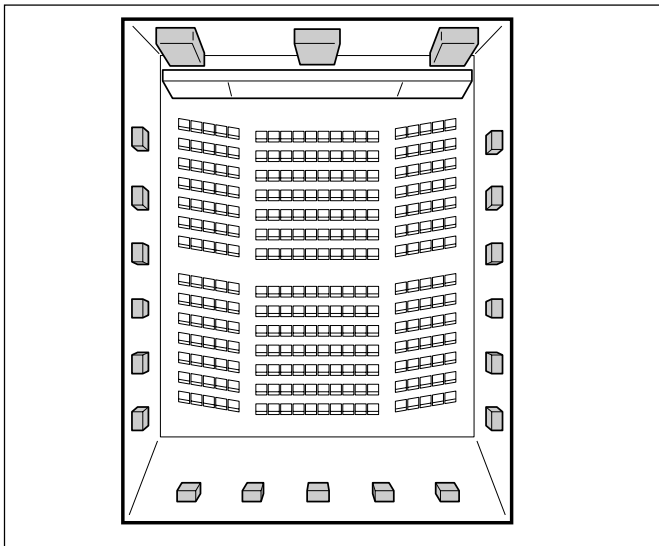

## Introducing the Surround Modes

### Dolby Digital\*1 and Dolby Surround

Dolby Digital is a digital signal compression method, developed by Dolby Laboratories, and enables multi-channel encoding and decoding (1 channel up to 5.1 channel—total 6 channels, but the LFE channel is counted as 0.1 channel. Therefore, called 5.1 channel).

Dolby Surround is an encoding format, developed by Dolby Laboratories, and decoding it with Dolby Pro Logic, Dolby Pro Logic II, or Dolby Pro Logic IIx enables multi-channel playback.

- When Dolby Digital signal is detected through the digital input, the  DIGITAL indicator lights up on the display.

### Dolby Pro Logic IIx

Dolby Pro Logic IIx is a newly introduced multi-channel playback format to convert not only multi-channel software but 2-channel software into 6.1 channel (or 7.1 channel) that developed from Dolby Pro Logic II. The matrix-based conversion method used for Dolby Pro Logic IIx makes no limitation for the cutoff frequency of the surround treble.

- This receiver provides two types of Dolby Pro Logic IIx modes—**Pro Logic IIx Movie** (PLIIx MOVIE) and **Pro Logic IIx Music** (PLIIx MUSIC).

When Dolby Pro Logic IIx is activated, “PLIIx MOVIE” or “PLIIx MUSIC” appear and the  PRO LOGIC II indicator lights up on the display.

---

**PLIIx MOVIE** Suitable for playing any Dolby Surround encoded software. You can enjoy a sound field very close to the one created with discrete 6.1-channel sounds.

---

**PLIIx MUSIC** Suitable for playing any 2-channel stereo software. You can enjoy wide and deep 6.1-channel sounds.

---

### Dolby Pro Logic II

Dolby Pro Logic II is a multi-channel playback format to convert 2-channel software into 5.1 channel.

- This receiver provides two types of Dolby Pro Logic II modes—**Pro Logic II Movie** (PLII MOVIE) and **Pro Logic II Music** (PLII MUSIC).

When Dolby Pro Logic II is activated, the  PRO LOGIC II indicator lights up on the display.

---

**PLII MOVIE** Suitable for playing any Dolby Surround encoded software. You can enjoy a sound field very close to the one created with discrete 5.1-channel sounds.

---

**PLII MUSIC** Suitable for playing any 2-channel stereo software. You can enjoy wide and deep sounds.

---

### Dolby Pro Logic

Dolby Surround encoding format records the left front channel, right front channel, center channel, and surround channel (monaural) signals into 2 channels.

The Dolby Pro Logic (PRO LOGIC) decoder built in this receiver decodes these 2-channel signals into 4 original channel signals (plus subwoofer)—matrix-based multi-channel reproduction.

- When Dolby Pro Logic is activated, the  PRO LOGIC indicator lights up on the display.

## Dolby Digital EX

Dolby Digital EX (DOLBY D EX) is a digital surround encoding format that adds the third surround channels, called “surround back.” Compared to the conventional Dolby Digital 5.1CH, these newly added surround back channels can reproduce more detailed movements behind you while viewing the video software. In addition, surround sound localization will become more stable.

- You can use Virtual 6.1-channel surround when playing back Dolby Digital EX software without connecting the surround back speakers. This reproduces the back sound field as if the surround back speakers exist, so that you can still feel the great surround effect from behind. The VIRTUAL SB (Surround Back) indicator lights up on the display.

## Dolby Digital 5.1CH

Dolby Digital 5.1CH (DOLBY D) encoding method records and digitally compresses the left front channel, right front channel, center channel, left surround channel, right surround channel, and LFE channel signals.

Dolby Digital enables stereo surround sounds, and sets the cutoff frequency of the surround treble at 20 kHz, compared to 7 kHz for Dolby Pro Logic. As such, the sound movement and “being-there” feeling are enhanced much more than Dolby Pro Logic.

## DTS\*2

DTS is another digital signal compression method, developed by Digital Theater Systems, Inc., and enables multi-channel encoding and decoding (1ch up to 6.1ch).

- When DTS signal is detected through the digital input, the  indicator lights up on the display.

## DTS Extended Surround (DTS-ES)

DTS-ES is another multi-channel digital encoding format.

It greatly improves the 360-degree surround impression and space expression by adding the third surround channel—surround back channel.

DTS-ES includes two signal formats with different surround signal recording methods—**DTS-ES Discrete 6.1ch** (ES DSCRT) and **DTS-ES Matrix 6.1ch** (ES MATRIX).

**DTS-ES Discrete 6.1ch** has been designed to encode (and decode) a 6.1-channel signal discretely to avoid interference with each channel.

**DTS-ES Matrix 6.1ch** has been designed to add an extra surround channel to DTS Digital Surround 5.1 channel. By using a matrix encoding/decoding method, an additional “surround back” channel signal is encoded (and decoded) in both the left and right surround channel signals.

- You can use Virtual 6.1-channel surround when playing back DTS-ES software without connecting the surround back speakers. This reproduces the back sound field as if the surround back speakers exist, so that you can still feel the great surround effect from behind. The VIRTUAL SB (Surround Back) indicator lights up on the display.

## DTS 96/24

In recent years, there has been increasing interest in higher sampling rates both for recording and for reproducing at home. Higher sampling rates allow wider frequency range and greater bit depths provide extended dynamic range.

DTS 96/24 is a digital signal format (fs 96 kHz/24 bits) introduced by Digital Theater Systems, Inc. to deliver “better-than-CD sound quality” into the home.

- When DTS 96/24 signal is detected, the  and 96/24 indicators light up on the display. You can enjoy its sound with full-quality.

## DTS Neo:6

DTS Neo:6 is another conversion method to create 6 channel (plus subwoofer) from analog/digital 2-channel software by using the high precision digital matrix decoder used for DTS-ES Matrix 6.1ch. When one of Neo:6 modes is activated, the NEO:6 indicator lights up on the display.

- This receiver provides the following DTS NEO:6 modes—**Neo:6 Cinema** (NEO:6CINMA) and **Neo:6 Music** (NEO:6MUSIC). When DTS NEO:6 is activated, the NEO:6 indicator lights up on the display.

---

**NEO:6CINMA** Suitable for playing movies. You can get the same atmosphere with 2-channel software as with 6.1-channel software. It is also effective for playing software encoded with conventional surround formats.

---

**NEO:6MUSIC** Suitable for playing music software. The front channel signals bypass the decoder (resulting in no loss of sound quality) and the surround signals transmitted through the other speakers expand the sound field naturally.

---

## DTS Digital Surround

DTS Digital Surround (DTS) is another discrete 5.1-channel digital audio format available on CD, LD, and DVD software.

Compared to Dolby Digital, the DTS Digital Surround format has a lower audio compression rate which enables it to add breadth and depth to the sounds reproduced. As such, DTS Digital Surround features natural, solid, and clear sound.

- When EX/ES/PLIIX setting is set to “ON,” DTS plus Neo:6 (DTS + NEO:6) is applied while playing back multi-channel DTS software. It creates the same surround ambience as 6.1-channel software does.

### What is Dual Mono?

Dual Mono can be easily understood when you think of the bilingual broadcast or the MTS (Multichannel Television Sound) format used for TV programs (however, the Dual Mono format is not identical with those analog formats).

This format is now adopted in Dolby Digital, DTS, and so on. It allows two independent channels (called main channel and sub-channel) to be recorded separately.

- When Dual Mono signal is detected, the DUAL indicator lights up on the display. You can select either channel you want to listen to (see page 36).

**When using the Surround mode, the sounds come out of the activated speakers which the Surround mode requires.**

- **If either the surround speakers or center speaker is set to “NONE” in the speaker setting,** the corresponding channel signals are allocated to and emitted through the front speakers.
- **If both the surround speakers and center speaker are set to “NONE” in the speaker setting,** JVC’s original 3D-PHONIC processing (which has been developed to create the surround effect through the front speakers only) is used. The 3D-PHONIC indicator lights up on the display.

\*1 Manufactured under license from Dolby Laboratories. “Dolby”, “Pro Logic”, and the double-D symbol are trademarks of Dolby Laboratories.

\*2 “DTS”, “DTS-ES”, “Neo:6” and “DTS 96/24” are trademarks of Digital Theater Systems, Inc.

## Activating the Surround Modes

Available Surround modes vary depending on the speaker settings and the incoming signals. (See pages 46 and 47.)

Activating one of the Surround modes for a source automatically recalls the memorized settings and adjustments (see pages 32 to 41).

You can also use the buttons on the remote control for the same functions.

### IMPORTANT:

Check the following before or while using the buttons and controls.

#### For Zone 1 operations:

The ZONE 1 indicator lights up on the unit's display.

- **When using the unit:**
  - “ZONE2” is not shown in the unit's main display.
- **When using the remote control:**
  - Set the ZONE 1/ZONE 2 selector to **ZONE 1**.
  - Check the indication shown on the remote's display when you press a button—this indicates the remote control operation mode together with multi-room operation mode (either for ZONE 1 or ZONE 2) for about two hours.

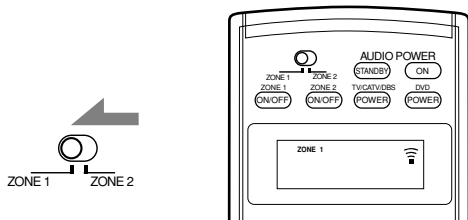

Ex. When you press SURROUND with ZONE 1/ZONE 2 selector set to ZONE 1.

## Activating the Surround modes

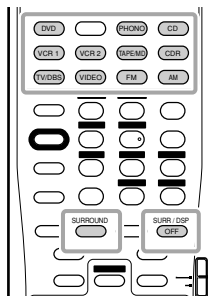
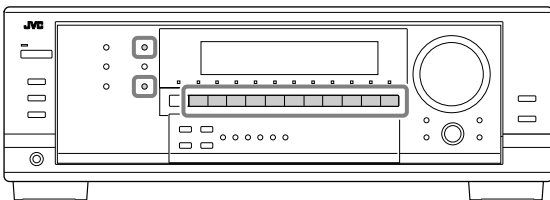

### 1. Select and play any source excluding DVD MULTI.

- Make sure you have selected the analog or digital input mode correctly.
- Surround modes are not valid for DVD MULTI playback mode.

### 2. Press SURROUND to activate the Surround mode.

- **For multi-channel digital software**, incoming signals are automatically detected and the appropriate Surround mode is activated (see pages 46 and 47 for details).

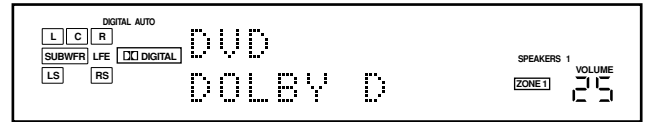

Ex. When “DOLBY D” is activated.

- Surround mode automatically activated also varies with the EX/ES/PLIIx setting.

- **For analog sources and digital 2-channel software**, you can select one of the following Surround modes. Each time you press SURROUND, the Surround modes change as follows:

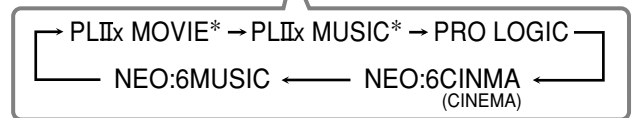

\* In the following cases, “PLII MOVIE” or “PLII MUSIC” is applied:

- When the surround back speakers are set to “NONE.”
- When EX/ES/PLIIx setting is set to “EX/ES OFF.”
- When the Zone 2 speakers are activated.

- **For Dual Mono software**, you can select the channel you listen to. (See page 36.)

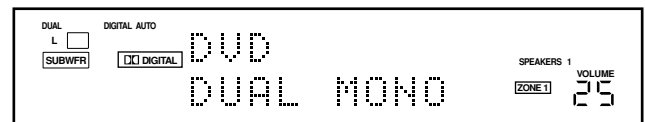

To adjust the speaker output level, see pages 40 and 41.

### Note:

When the Zone 2 speakers are activated or the surround speakers are set to “NONE,” the 3D-PHONIC processing is applied to the Surround modes (the 3D-PHONIC indicator also lights up).

### To cancel the Surround modes

Press SURROUND/DSP OFF (or SURR/DSP OFF on the remote control).

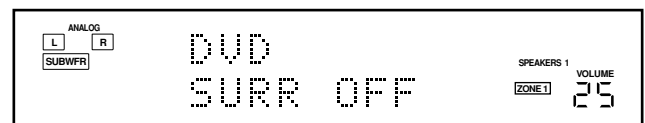

## ■ Activating the EX/ES/PLIIx setting

For multi-channel digital software, you can activate the EX/ES/PLIIx (6.1-channel) reproduction mode.

- Once you have set EX/ES/PLIIx (6.1-channel) reproduction mode, it is stored in memory and will be called up whenever you activate the Surround mode which the memorized EX/ES/PLIIx (6.1-channel) reproduction mode can be applied to.

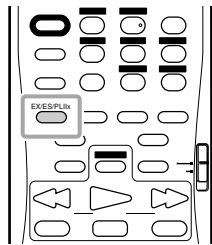
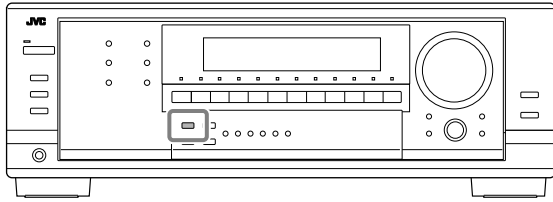

Press EX/ES/PLIIx to select an appropriate setting for your enjoyment.

The currently selected EX/ES/PLIIx (6.1-channel) reproduction mode appears on the display.

- Each time you press the button, it changes as follows:  
For details of applicable Surround mode, see “Surround Modes Applicable to the Various Software” on pages 46 and 47.

<b>EX/ES:AUTO</b>	According to the incoming signal, an appropriate Surround mode is applied. <ul style="list-style-type: none"> <li>• For Dolby Digital EX and DTS-ES, 6.1-channel reproduction is applied.</li> <li>• For other multi-channel (more than 4 channel) encoded software, 5.1-channel reproduction is applied.</li> </ul>
<b>EX/ES:ON*1</b>	Select to apply 6.1-channel reproduction to both 5.1-channel and 6.1-channel encoded software.
<b>PLIIx MOVIE*1 *2</b>	Select to apply PLIIx MOVIE (6.1-channel) reproduction to both 5.1-channel and 6.1-channel encoded software.
<b>PLIIx MUSIC*1</b>	Select to apply PLIIx MUSIC (6.1-channel) reproduction to both 5.1-channel and 6.1-channel encoded software.
<b>EX/ES:OFF*3</b>	Select to cancel the EX/ES/PLIIx (6.1-channel) reproduction.

\*1 When you have set the surround back speakers to “NONE” (see page 34), you can enjoy up to 5.1-channel sounds using the VIRTUAL SB (Surround Back).

\*2 When using PLIIx Movie to reproduce Dolby Digital or DTS software, this receiver applies Dolby Digital EX (DOLBY D EX) or DTS plus Dolby Digital EX (DTS + DD EX) processing (6.1-channel reproduction) to the software.

\*3 When “EX/ES:OFF” is selected, “PLII MOVIE” and “PLII MUSIC” will be activated for 2-channel software. (See page 44.)

### Notes:

- If you want to use “PLIIx MOVIE” or “PLIIx MUSIC” for analog sources or digital 2-channel software, select “EX/ES:AUTO,” “EX/ES:ON,” “PLIIx MOVIE,” or “PLIIx MUSIC” in this setting.
- When the Zone 2 speakers are activated or the surround speakers are set to “NONE,” you cannot activate this setting and “NO SURR SP” appears on the display.

## Surround Modes Applicable to the Various Software

Available Surround modes vary depending on the speaker settings and the incoming signals.

The table below shows the relation of the Surround modes and the incoming signals (with the Zone 2 speakers, surround back speakers, and 6.1-channel reproduction mode setting).

- The numbers inside the parentheses following the incoming signal type indicate the number of the front channels and that of the surround channels. For example, (3/2) indicates that the signals are encoded with three front signals (left/right/center) and two (stereo) surround signals.

Incoming Signal Type	Zone 2 Speakers	Surround Back Channel Setting	EX/ES/PLIIX Setting	Available Surround Mode
Dolby Digital EX	<b>Activated</b>	Not effective	Not effective	DOLBY D (3D-PHONIC)*2
*1 When EX/ES/PLIIX setting is set to "AUTO," "DOLBY D" is applied to certain softwares.	<b>Deactivated</b>	<b>2SPK/1SPK</b>	<b>AUTO/ON/PLIIX MOVIE</b>	DOLBY D EX*1 *3
			<b>PLIIX MUSIC</b>	DD + PLIIX MU
			<b>OFF</b>	DOLBY D
	<b>NONE</b>	<b>AUTO/ON/PLIIX MOVIE/PLIIX MUSIC</b>	DOLBY D (VIRTUAL SB)*1 *4	
		<b>OFF</b>	DOLBY D	
Dolby Digital (3/2, 2/2)	<b>Activated</b>	Not effective	Not effective	DOLBY D (3D-PHONIC)*2
	<b>Deactivated</b>	<b>2SPK/1SPK</b>	<b>ON/PLIIX MOVIE</b>	DOLBY D EX*3
			<b>PLIIX MUSIC</b>	DD + PLIIX MU
			<b>AUTO/OFF</b>	DOLBY D
	<b>NONE</b>	<b>ON/PLIIX MOVIE/PLIIX MUSIC</b>	DOLBY D (VIRTUAL SB)*4	
<b>AUTO/OFF</b>		DOLBY D		
Dolby Digital (3/1, 2/1, 3/0, 1/0)	<b>Activated</b>	Not effective	Not effective	DOLBY D (3D-PHONIC)*2
	<b>Deactivated</b>	Not effective	Not effective	DOLBY D
Dolby Digital (Dual Mono)	Not effective	Not effective	Not effective	DUAL MONO

Incoming Signal Type	Zone 2 Speakers	Surround Back Channel Setting	EX/ES/PLIIX Setting	Available Surround Mode
Analog Linear PCM Dolby Surround Dolby Digital (2/0) DTS (2/0)	<b>Activated</b>	Not effective	Not effective	PLII MOVIE/PLII MUSIC/ PRO LOGIC/ NEO:6CINMA/NEO:6MUSIC (3D-PHONIC)
	<b>Deactivated</b>	<b>2SPK/1SPK</b>	<b>AUTO/ON/PLIIX MOVIE/PLIIX MUSIC</b>	PLIIX MOVIE/PLIIX MUSIC/ PRO LOGIC/ NEO:6CINMA/NEO:6MUSIC
			<b>OFF</b>	PLII MOVIE/PLII MUSIC/ PRO LOGIC/ NEO:6CINMA/NEO:6MUSIC
			<b>NONE</b>	Not effective
DVD MULTI	<b>Deactivated</b> *5	Not effective	Not effective	None

\*5 When activating Zone 2 speakers, you cannot use the DVD MULTI playback mode.



Incoming Signal Type	Zone 2 Speakers	Surround Back Channel Setting	EX/ES/PLIIx Setting	Available Surround Mode
DTS-ES Discrete 6.1ch	Activated	Not effective	Not effective	DTS (3D-PHONIC)* <sup>2</sup>
	Deactivated	2SPK/1SPK	AUTO/ON	ES DSCRT
			PLIIx MOVIE	DTS + DD EX* <sup>3</sup>
			PLIIx MUSIC	DTS + PLIIx MU
			OFF	DTS
	NONE	AUTO/ON/PLIIx MOVIE/PLIIx MUSIC	DTS (VIRTUAL SB)* <sup>4</sup>	
OFF		DTS		
DTS-ES Matrix 6.1ch DTS-ES 96/24 Matrix	Activated	Not effective	Not effective	DTS (3D-PHONIC)* <sup>2</sup>
	Deactivated	2SPK/1SPK	AUTO/ON	ES MATRIX* <sup>6</sup>
			PLIIx MOVIE	DTS + DD EX* <sup>3</sup> * <sup>6</sup>
			PLIIx MUSIC	DTS + PLIIx MU* <sup>6</sup>
			OFF	DTS
	NONE	AUTO/ON/PLIIx MOVIE/PLIIx MUSIC	DTS (VIRTUAL SB)* <sup>4</sup> * <sup>6</sup>	
OFF		DTS		
DTS, DTS 96/24 (3/2, 2/2)	Activated	Not effective	Not effective	DTS (3D-PHONIC)* <sup>2</sup>
	Deactivated	2SPK/1SPK	ON	DTS + NEO:6* <sup>6</sup>
			PLIIx MOVIE	DTS + DD EX* <sup>3</sup> * <sup>6</sup>
			PLIIx MUSIC	DTS + PLIIx MU* <sup>6</sup>
			AUTO/OFF	DTS
	NONE	ON/PLIIx MOVIE/PLIIx MUSIC	DTS (VIRTUAL SB)* <sup>4</sup> * <sup>6</sup>	
AUTO/OFF		DTS		
DTS (3/1, 2/1, 3/0, 1/0)	Activated	Not effective	Not effective	DTS (3D-PHONIC)* <sup>2</sup>
	Deactivated	Not effective	Not effective	DTS
DTS (Dual Mono)	Not effective	Not effective	Not effective	DUAL MONO

\*<sup>2</sup> When the Zone 2 speakers are activated, the 3D-PHONIC processing is applied to reproduce Dolby Digital or DTS software (the 3D-PHONIC indicator also lights up).

\*<sup>3</sup> When using PLIIx Movie to reproduce Dolby Digital or DTS software, this receiver applies Dolby Digital EX (DOLBY D EX) or DTS plus Dolby Digital EX (DTS + DD EX) processing (6.1-channel reproduction) to the software.

#### \*<sup>4</sup> Virtual 6.1-channel surround

If you have connected (and activated) the surround speakers, you can use Virtual 6.1-channel surround when playing back Dolby Digital EX, Dolby Digital (3/2 or 2/2) or DTS-ES software without connecting the surround back speakers. This surround reallocates the surround back channel to the surround speakers so that you can still feel the great surround effect from behind. The VIRTUAL SB (Surround Back) indicator lights up on the display.

#### 3D Headphone mode—3D H PHONE

If you press SURROUND when the front speakers 1 and 2 are both deactivated, 3D Headphone mode (3D H PHONE) is activated without respect to the type of software played back. "3D H PHONE" appears and the DSP and HEADPHONE indicators also light up on the display.

# Using the DSP Modes

This unit can activate a variety of DSP modes. The basic settings and adjustments stored (see pages 32 to 41) are applied.

- The following operations are only possible when the receiver is ready for Zone 1 operations, and are used only for Zone 1 sources.

## Reproducing the Sound Field

The sound heard in a concert hall, club, etc. consists of direct sound and indirect sound—early reflections and reflections from behind. Direct sounds reach the listener directly without any reflection. On the other hand, indirect sounds are delayed by the distances of the ceiling and walls. These direct sounds and indirect sounds are the most important elements of the acoustic surround effects. DSP modes can create these important elements, and give you a real “being there” feeling.

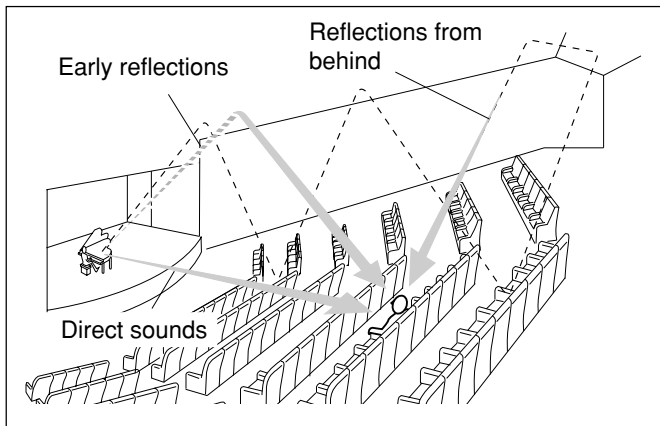

## Introducing the DSP Modes

DSP modes include the following modes—

- Digital Acoustic Processor (DAP) modes (HALL 1, HALL 2, LIVE CLUB, DANCE CLUB, PAVILION, THEATER 1, THEATER 2)
- ALL STEREO
- MONO FILM—Used for all types of 2-channel signals (including Dual Mono signal)

### 3D Headphone mode—3D H PHONE

If you press DSP when the front speakers 1 and 2 are both deactivated, 3D Headphone mode (3D H PHONE) is activated without respect to the type of software played back. “3D H PHONE” appears and the DSP and HEADPHONE indicators also light up on the display.

To use DSP modes, press DSP so that the DSP modes change as follows.

The DSP indicator also lights up on the display.

→ HALL 1	→ HALL 2	→ LIVE CLUB
→ DANCE CLUB	→ PAVILION	→ ALL STEREO
→ THEATER 1	→ THEATER 2	→ MONO FILM
→ (Back to the beginning)		

: Suitable for audio sources  
 : Suitable for video sources

## Digital Acoustic Processor (DAP) modes

You can use the following DAP modes in order to reproduce a more acoustic sound field in your listening room.

<b>HALL 1</b>	Reproduces the spatial feeling of a large shoebox-shaped hall designed primarily for classical concerts. (Its seating capacity is about 2000.)
<b>HALL 2</b>	Reproduces the spatial feeling of a large vineyard-shaped hall designed primarily for classical concerts. (Its seating capacity is about 2000.)
<b>LIVE CLUB</b>	Reproduces the spatial feeling of a live music club with a low ceiling.
<b>DANCE CLUB</b>	Reproduces the spatial feeling of a rocking dance club.
<b>PAVILION</b>	Reproduces the spatial feeling of an exhibition hall with a high ceiling.
<b>THEATER 1*</b>	Reproduces the spatial feeling of a large theater where the seating capacity is about 600.
<b>THEATER 2*</b>	Reproduces the spatial feeling of a small theater where the seating capacity is about 300.

\* The built-in Dolby Pro Logic II decoder is activated when playing back 2-channel analog or digital source. The **PRO LOGIC II** indicator lights up on the display.

When using the DAP mode, the sounds come out of all the connected and activated speakers.

- If the surround speakers are set to “NONE” in the speaker setting, JVC’s original 3D-PHONIC processing (which has been developed to create the surround effect through the front speakers only) is used. The 3D-PHONIC indicator lights up on the display.

## Mono Film

In order to reproduce a more acoustic sound field in your listening room while viewing monaural sound video software (analog, 2-channel digital, and Dual Mono signals), you can use this mode. The surround effect will be added, and the sound localization of actor’s words will be improved. **This mode cannot be used for multi-channel digital signals.**

When “MONO FILM” is used, the sounds come out of all the connected and activated speakers.

- If surround speakers are set to “NONE” in the speaker setting, JVC’s original 3D-PHONIC processing (which has been developed to create the surround effect through the front speakers only) is used. The 3D-PHONIC indicator lights up on the display.
- If incoming signals change from 2-channel digital signal to another digital signal type, “MONO FILM” is canceled and an appropriate Surround mode is activated.

### All channel stereo mode

This mode can reproduce a larger stereo sound field using all the connected (and activated) speakers.

- If the surround speakers are set to "NONE," you cannot select "ALL STEREO."

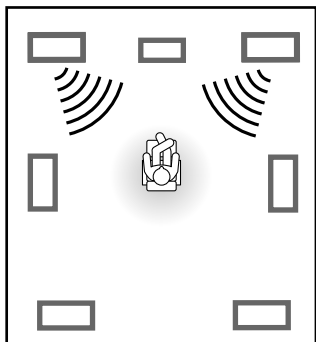

Sound reproduced from normal stereo

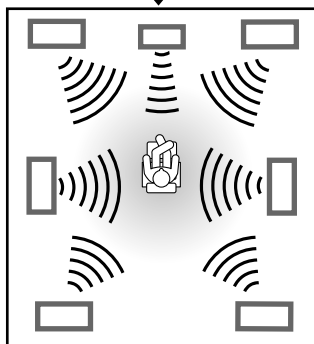

Sound reproduced from All Channel Stereo mode

### Activating the DSP Modes

Activating one of the DSP modes for a source automatically recalls the memorized settings and adjustments (see pages 32 to 41).

You can also use the buttons on the remote control for the same functions.

#### IMPORTANT:

Check the following before or while using the buttons and controls.

#### For Zone 1 operations:

The ZONE 1 indicator lights up on the unit's display.

- **When using the unit:**
  - "ZONE2" is not shown in the unit's main display.
- **When using the remote control:**
  - Set the ZONE 1/ZONE 2 selector to **ZONE 1**.
  - Check the indication shown on the remote's display when you press a button—this indicates the remote control operation mode together with multi-room operation mode (either for ZONE 1 or ZONE 2) for about two hours.

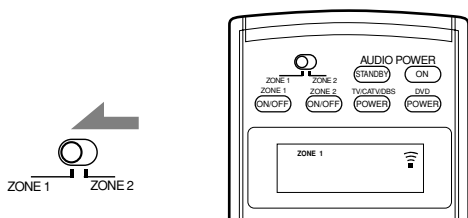

Ex. When you press DSP with ZONE 1/ZONE 2 selector set to ZONE 1.

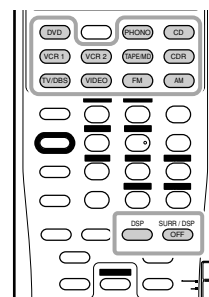
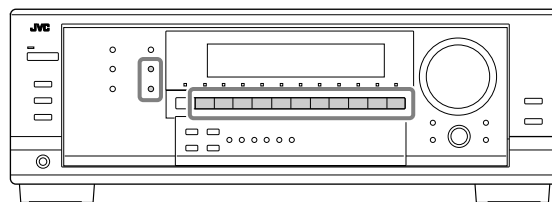

#### 1. Select and play any source excluding DVD MULTI.

- Make sure you have selected the analog or digital input mode correctly.
- DSP modes are not valid for DVD MULTI playback mode.

#### 2. Press DSP repeatedly until the DSP mode you want appears on the display.

- Each time you press the button, the DSP modes change as follows:



- HALL 1      → HALL 2      → LIVE CLUB
- DANCE CLUB → PAVILION      → ALL STEREO\*<sup>1</sup>
- THEATER 1   → THEATER 2   → MONO FILM\*<sup>2</sup>
- (Back to the beginning)

\*<sup>1</sup> When the surround speakers are set to "NONE," you cannot select "ALL STEREO."

\*<sup>2</sup> When multi-channel signals come in, you cannot select "MONO FILM."

#### Note:

When the Zone 2 speakers are activated or the surround speakers are set to "NONE," the 3D-PHONIC processing is applied to the DSP modes (the 3D-PHONIC indicator also lights up).

To adjust the effect level (except All Channel Stereo), see page 41.

#### To cancel the DSP modes

Press SURROUND/DSP OFF (or SURR/DSP OFF on the remote control).

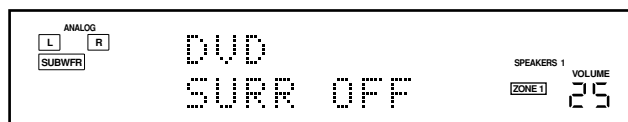

# Using the DVD MULTI Playback Mode

This receiver provides the DVD MULTI playback mode for reproducing the analog discrete output mode of the DVD player.

- The following operations are only possible when the receiver is ready for Zone 1 operations, and are used only for Zone 1 sources.

## Connection diagram

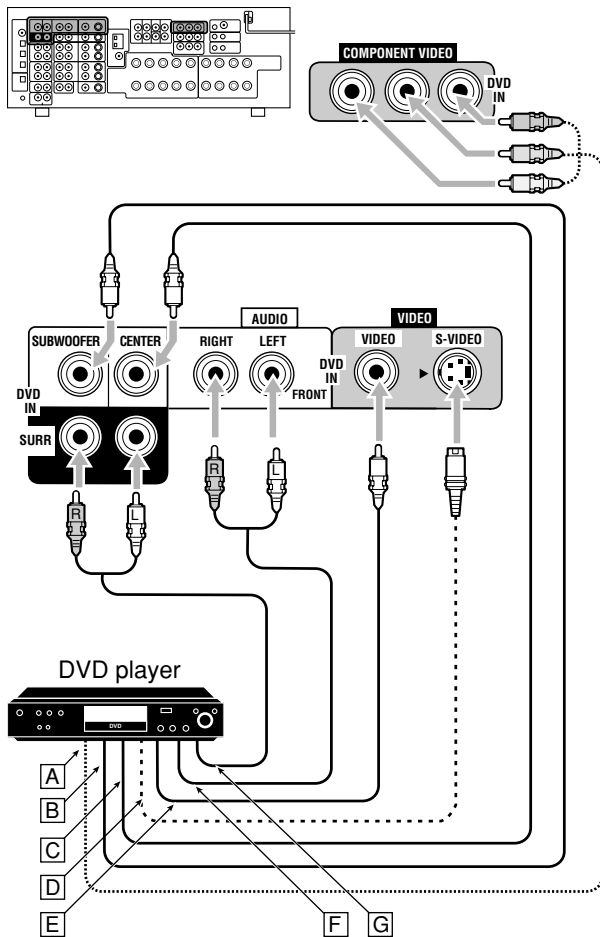

- A To component video output
- B To subwoofer output
- C To center channel audio output
- D To S-video output
- E To composite video output
- F To left/right front channel audio output
- G To left/right surround channel audio output

### Note:

When connecting a DVD player to the component video input jacks, make the component video input setting (VIDEO IN DVD) correctly. See page 38 for details.

## Activating the DVD MULTI Playback Mode

DVD MULTI playback mode is the best connection method for enjoying DVD Audio sounds.

- When a DVD Audio disc is played back, the original high-quality sounds can be reproduced only using this mode.

### IMPORTANT:

Check the following before or while using the buttons and controls.

#### For Zone 1 operations:

The ZONE 1 indicator lights up on the unit's display.

- When using the unit:**
  - “ZONE2” is not shown in the unit's main display.
- When using the remote control:**
  - Set the ZONE 1/ZONE 2 selector to **ZONE 1**.
  - Check the indication shown on the remote's display when you press a button—this indicates the remote control operation mode together with multi-room operation mode (either for ZONE 1 or ZONE 2) for about two hours.

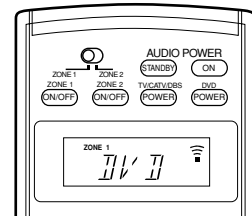
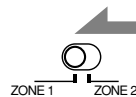

Ex. When you press DVD MULTI with ZONE 1/ZONE 2 selector set to ZONE 1.

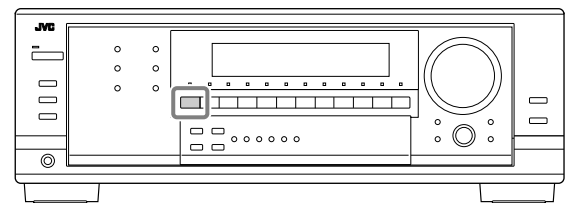

- Press DVD MULTI so that “DVD” appears on the display.

The MULTI indicator also lights up.

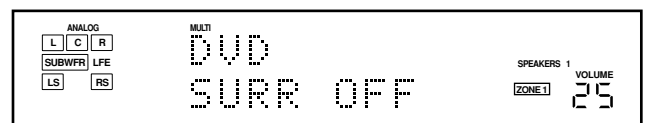

### Note:

When you select DVD MULTI as the source to play, the Surround and DSP modes are canceled, and the SURROUND and DSP buttons do not work.

- Select the analog discrete output mode on the DVD player, and start playing a DVD.

- Refer also to the manual supplied with the DVD player.

You can adjust equalization patterns and speaker output levels. See “Adjusting the equalization patterns” on page 40 for details.

### Notes:

- When activating Zone 2 speakers, you cannot use the DVD MULTI playback mode.
- Midnight Mode is not available for DVD MULTI playback mode (see page 23).
- When using a headphones, you can listen to the front channels (left and right) only. 3D Headphone (3D H PHONE) mode is not valid for DVD MULTI playback mode.

# COMPU LINK Remote Control System

The COMPU LINK remote control system allows you to operate JVC's audio components through the remote sensor on the receiver.

- Refer also to the manuals supplied with your audio components.

To use this remote control system, you need to connect JVC's audio components through the COMPU LINK (SYNCHRO) jacks (see below) in addition to the connections using cables with RCA pin plugs (see pages 10 and 11).

- Make sure that the AC power cords of these components are unplugged before connection. Plug the AC power cords only after all connections are complete.

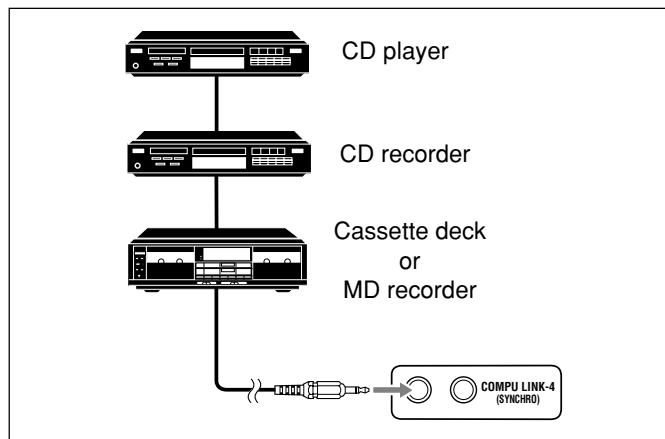

## Notes:

- There are four versions of COMPU LINK remote control system. This receiver is equipped with the fourth version—COMPU LINK-4. This version is added systematic operations with the CD recorder to the previous version—COMPU LINK-3.
- If your audio component has two COMPU LINK jacks, you can use either one. If it has only one COMPU LINK jack, connect it so that it is the last item in the series of components.
- To operate the cassette deck or MD recorder using the COMPU LINK remote control system, set the source name correctly if required. (See page 24.)
- Refer also to the manuals supplied for your audio components.

## IMPORTANT:

Check the following before or while using the buttons and controls.

### For Zone 1 operations:

The ZONE 1 indicator lights up on the unit's display.

### For Zone 2 operations:

The ZONE 2 indicator lights up on the unit's display.

### When using the unit:

- For Zone 1 operations: "ZONE2" is not shown in the unit's main display.
- For Zone 2 operations: "ZONE2" is shown in the unit's main display.

### When using the remote control:

**When operating the receiver using the remote control, the unit's display always shows the Zone 1 source information though you are operating it for the Zone 2 source.**

- Set the ZONE 1/ZONE 2 selector to **ZONE 1** or **ZONE 2** correctly.
- Check the indication shown on the remote's display when you press a button—this indicates the remote control operation mode together with multi-room operation mode (either for ZONE 1 or ZONE 2) for about two hours.

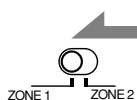

Ex. When you set ZONE 1/  
ZONE 2 selector to ZONE 1.

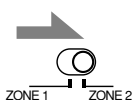

Ex. When you set ZONE 1/  
ZONE 2 selector to ZONE 2.

This remote control system allows you to use four functions listed below.

### Remote Control through the Remote Sensor on the Receiver Zone 2

You can control the connected audio components through the remote sensor on the receiver using this remote control. Aim the remote control directly at the remote sensor on the receiver. For details, see pages 56 and 57.

### Note:

When using RF rod antenna (see page 14), it is unnecessary for aiming directly at the remote sensor on the receiver.

### Automatic Source Selection Zone 2

- When you press the play (▶) button on a connected component or on its own remote control, the receiver automatically turns on and changes the **Zone 1** source to the component.



Ex. When you operate the CD player for Zone 1

- If the receiver is already turned on with the ZONE 2 indicator lights up and the source name for Zone 2 appears on the unit's display, the receiver changes the **Zone 2** source to the component.

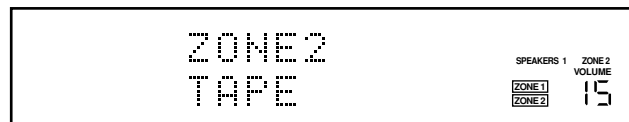

Ex. When you operate the cassette deck for Zone 2

- When you press PLAY on the remote control supplied for this receiver, the receiver automatically turns on and changes the **Zone 1** source or **Zone 2** source to the target component, depending on ZONE 1/ZONE 2 selector setting on the remote control.
- When you select a new source on the receiver or on the remote control supplied for this receiver either for **Zone 1** or **Zone 2**, the newly selected component begins playing immediately, and the previously selected source continues playing without sound for a few seconds.

**Automatic Power On/Off (Standby)—only possible with the COMPU LINK-3 and COMPU LINK-4**



The CD player, CD recorder, and Cassette deck (or MD recorder) turn on and off along with the receiver.

**Automatic Power On:**

- **When you turn on the receiver by pressing  $\odot$ /STANDBY/ON on the unit, or AUDIO POWER ON on the remote control with ZONE 1/ZONE 2 selector set to ZONE 1:**

OR

**When you turn on the Zone 1 sound by pressing ZONE 1 ON/OFF while the receiver is turned on:**

➔ The ZONE 1 indicator lights up, and the source name for Zone 1 appears on the unit's display, and one of the connected components will turn on automatically, depending on which component has been previously selected as the **Zone 1 source**.

- **When you turn on the receiver by pressing AUDIO POWER ON on the remote control with ZONE 1/ZONE 2 selector set to ZONE 2:**

OR

**When you turn on the Zone 2 sound by pressing ZONE 2 ON/OFF while the receiver is turned on:**

➔ The ZONE 2 indicator lights up on the display and one of the connected components will turn on automatically, depending on which component has been previously selected as the **Zone 2 source**.

**Automatic Power Off (Standby):**

- **When you turn off the receiver by pressing  $\odot$ /STANDBY/ON on the unit or AUDIO POWER STANDBY on the remote control, the connected components will turn off (standby).**
- **When you turn off the Zone 1 sound by pressing ZONE 1 ON/OFF, the selected Zone 1 source component turns off (unless the same component is selected as the Zone 2 source).**
  - If the ZONE 2 indicator is lit, the **Zone 1 source** will stop playing, but will not turn off.
- **When you turn off the Zone 2 sound by pressing ZONE 2 ON/OFF, the selected Zone 2 source component turns off (unless the same component is selected as the Zone 1 source).**
  - If the ZONE 1 indicator is lit, the **Zone 2 source** will stop playing, but will not turn off.

**Synchronized Recording (Only for Zone 1 Operations)**

This operation is only possible when the receiver is ready for **Zone 1 operations**.

Synchronized recording means the cassette deck (or MD recorder) starts recording as soon as a CD begins playing.

To use synchronized recording, follow these steps:

- 1. Put a tape in the cassette deck (or an MD in the MD recorder), and a disc in the CD player.**
- 2. Press the record (●) button and the pause (⏸) button on the cassette deck (or on the MD recorder) at the same time.**

This puts the cassette deck (or MD recorder) into recording pause.

If you do not press the record (●) button and pause (⏸) button at the same time, the synchronized recording feature will not operate.

- 3. Press the play (▶) button on the CD player.**

The **Zone 1 source** changes on the receiver, and as soon as play starts, the cassette deck (or MD recorder) starts recording. When play ends, the cassette deck (or MD recorder) enters recording pause, and stops about 4 seconds later.

**Notes:**

- *During synchronized recording;*
  - *The selected Zone 1 source cannot be changed. (You can change the Zone 2 source.)*
  - *If the same source is selected both for Zone 1 and Zone 2, operating the Zone 2 source will affect the recording.*
- *The COMPU LINK remote control system may not operate properly during synchronized recording;*
  - *If the power of any playing or recording component is shut off.*
  - *If the Zone 1 sound is turned off by pressing ZONE 1 ON/OFF. In this case, you must start recording again from the beginning.*
- *You cannot use the CD recorder for synchronized recording.*

# AV COMPU LINK Remote Control System

This receiver is equipped with the AV COMPU LINK-III. The AV COMPU LINK remote control system allows you to operate JVC video components (VCR, DVD player, and TV) through the receiver. To use this remote control system, you need to connect the video components you want to operate, following the procedure below.

- Refer also to the manuals supplied with your video components.

1. If you have already plugged your VCR 1 (VCR connected to the VCR 1 jacks), DVD player, TV, and this receiver into the AC outlets, unplug their AC power cords first.
2. Connect the IR signal transmitter (supplied) to the IR OUT on the rear panel, and place it so that it is aimed at the remote sensor(s) on the target video component(s).
  - See "CONNECTIONS 1" below (and page 15 for details).
3. Connect your VCR 1, DVD player, TV, and this receiver through the AV COMPULINK jacks as follows, using cables with monaural mini-plugs (not supplied).
  - See "CONNECTIONS 2" below.
4. Connect the audio input/output jacks on the VCR 1, DVD player, TV, and this receiver using the cables with RCA pin plugs.
  - See pages 12 and 13.
5. Connect the video input/output jacks on the VCR 1, DVD player, TV, and this receiver, using the cables with RCA pin plugs, S-video plugs or component video plugs.
  - See "CONNECTIONS 3" on the next page (and pages 12 and 13 for details).
6. Plug the AC power cords of the components and this receiver into the AC outlets.
7. When turning on the TV for the first time after the AV COMPU LINK connection, turn the TV volume to the minimum using the TV volume control on the TV.
8. Turn on the other connected components first, then turn on this receiver.
  - When turning on the DVD player, use the remote control supplied with this receiver—press DVD POWER.

## CONNECTIONS 1: IR Signal Transmitter Connection

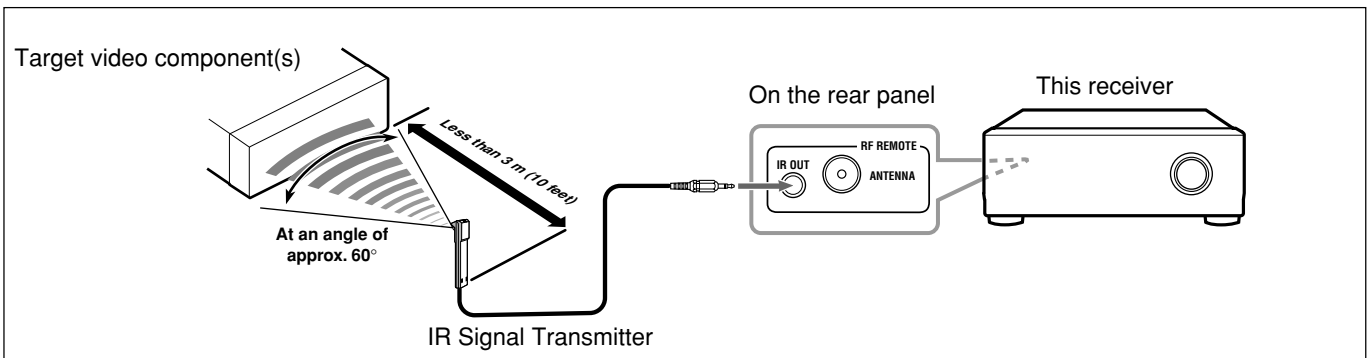

## CONNECTIONS 2: AV COMPU LINK Connection

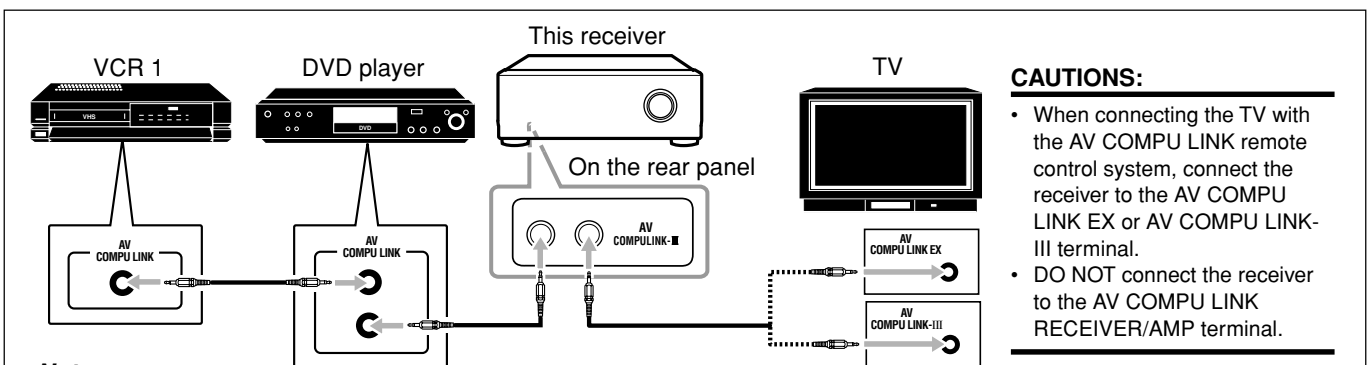

### CAUTIONS:

- When connecting the TV with the AV COMPU LINK remote control system, connect the receiver to the AV COMPU LINK EX or AV COMPU LINK-III terminal.
- DO NOT connect the receiver to the AV COMPU LINK RECEIVER/AMP terminal.

### Notes:

- The AV COMPU LINK remote control system cannot control the DBS tuner connected to the TV SOUND/DBS IN jacks, and video components connected to the VIDEO and VCR 2 IN jacks on the receiver.
- When connecting only the VCR 1 or DVD player to this receiver, connect it directly to the receiver using a cable with the monaural mini-plugs.
- When connecting the receiver and the TV with AV COMPU LINK EX terminal by using the component video cables, you cannot use "Automatic Selection of TV's Input Mode" (see page 55).

### CONNECTIONS 3: Video Cable Connection

This receiver is equipped with three types of the video terminals—S-video, composite video, and component video, and can output the signal through the output jack only the signal came from same type input jack. So you need to connect the VCR 1 and/or DVD player to the TV using one of the following three ways:

- **When using the AV COMPU LINK remote control system, set the component video input for the VCR 1 (VCR connected to the VCR 1 jacks) and DVD player correctly** (see “Setting the component video input” on page 38); otherwise, the correct input for this receiver will not be selected on the TV.

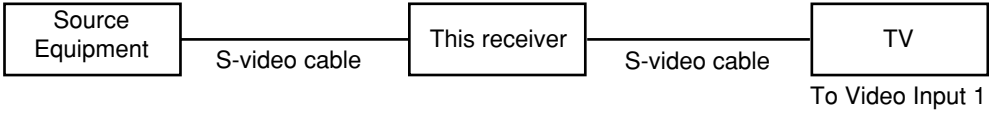
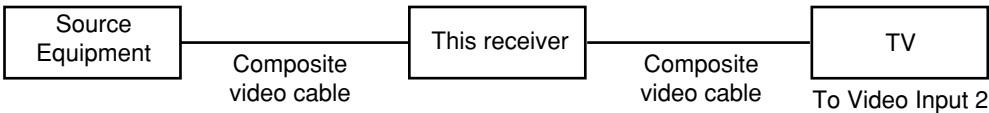
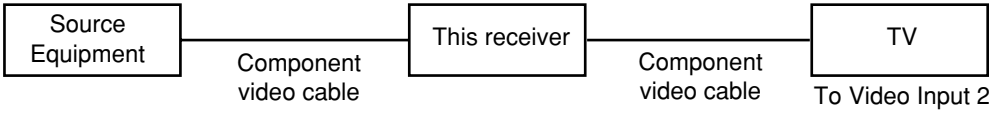
CASE 1	<p>When connecting the source equipment to the receiver through the <b>S-video jacks</b>, connect the receiver to the TV's Video Input 1 jack (S-video input) using S-video cables.</p> 
CASE 2	<p>When connecting the source equipment to the receiver through the <b>composite video jacks</b>, connect the receiver to the TV's Video Input 2 jack (composite video input) using composite video cables.</p> 
CASE 3	<p>When connecting the source equipment to the receiver through the <b>component video jacks</b>, connect the receiver to the TV's Video Input 2 jack (component video input) using component video cables.</p> 

The AV COMPU LINK remote control system allows you to use the five basic functions listed below.

#### Remote Control of the VCR, DVD player, and TV using This Remote Control

#### **IMPORTANT:**

To operate the video components using the IR signal transmitter (supplied), place it so that it is aimed at the remote sensor(s) on the target video component(s).

- The IR signal transmitter can send signals at a distance of 3 m (10 feet).

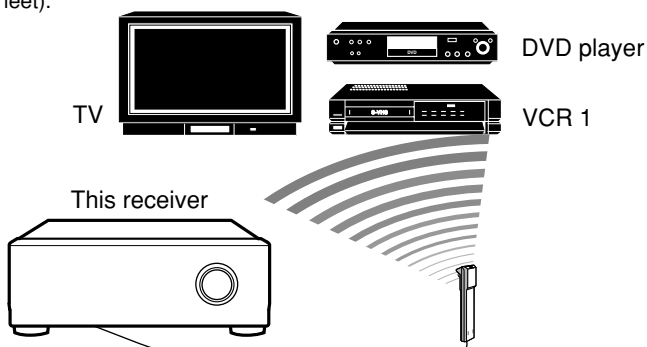

You can control the connected video components using this remote control. Aim the remote control at the remote sensor(s) on the target video component(s) or on the receiver directly. For details, see page 58.

#### **Note:**

To operate the video components from Zone 2, use the RF rod antenna and IR signal transmitter (see pages 14 and 15).

#### One-Touch Video Play

- Simply by inserting a video cassette without its safety tab into the VCR 1 (VCR connected to the VCR 1 jacks), you can watch the video playback without setting other switches manually. The receiver automatically turns on and changes the **Zone 1 source** to “VCR 1.” The TV automatically turns on and changes the input mode to the appropriate position so that you can view the playback picture. When you insert a video cassette with its safety tab in place, press the play (▶) button on the VCR or on its remote control. Thus, you can get the same result.
  - If the receiver is already turned on with the ZONE 2 indicator lights up and the source name for Zone 2 appears on the unit’s display, the receiver changes the **Zone 2 source** to “VCR 1.”
- When you press PLAY on the remote control supplied for this receiver for operating the VCR 1, the receiver automatically turns on and changes the **Zone 1 source** or **Zone 2 source** to “VCR 1”—depending on ZONE 1/ZONE 2 selector setting on the remote control.
  - For Zone 1 operations only: The TV automatically turns on and changes the input mode to the appropriate position so that you can view the playback picture.



## **One-Touch DVD Play**

Simply by starting playback on the DVD player, you can enjoy the DVD playback without setting other switches manually.

When you press PLAY on the remote control supplied for this receiver for operating the DVD player, the receiver automatically turns on and changes the **Zone 1 source** or **Zone 2 source**, depending on ZONE 1/ZONE 2 selector setting on the remote control, to the appropriate input—"DVD" or "DVD MULTI" as the Zone 1 source, and "DVD" as the Zone 2 source.

For Zone 1 operations: The TV automatically turns on and changes the input mode to the appropriate position so that you can view the playback picture.

- When the DVD player is connected through the analog input jacks on this receiver (and analog input is selected), the receiver automatically turns on and changes the source to "DVD" or "DVD MULTI."
  - If the receiver is already turned on with the ZONE 2 indicator and the source name for Zone 2 are shown on the unit's display, the receiver changes the **Zone 2 source** to "DVD." In this case, the TV will not turn on.
- When the DVD player is connected through the digital input terminal on this receiver (and digital input is selected), the receiver automatically turns on and changes the Zone 1 source to "DVD."
  - If the receiver is already turned on with the ZONE 2 indicator and the source name for Zone 2 are shown on the unit's display, the receiver changes the **Zone 2 source** to "DVD." (If no analog connection is made for the DVD player, no sound comes out of the Zone 2 front speakers).

## **Automatic Selection of TV's Input Mode (Only for Zone 1 Operations)**

- When you select "TV" as the **Zone 1 source** to play on the receiver, the TV automatically changes the input mode to the TV tuner so that you can watch the TV.
- When you select DVD, DVD MULTI, VCR 1, VCR 2, VIDEO or DBS as the **Zone 1 source** to play on the receiver, the TV automatically changes the input mode to the appropriate position (either Video Input 1 or Video Input 2) so that you can view the playback picture.

### **Note:**

*This function does not work when you connect this receiver and the TV with the AV COMPU LINK EX jack using a component video cable. In this case, reconnect the TV referring to CASE 1 or CASE 2 on page 54.*

## **Automatic Power On/Off (Standby)**

The TV (for Zone 1 only), VCR 1 (VCR connected to the VCR 1 jacks), and DVD player turn on and off along with the receiver.

### **Automatic Power On:**

- When you turn on the receiver by pressing  $\odot$ /I STANDBY/ON on the unit, or AUDIO POWER ON on the remote control with ZONE 1/ZONE 2 selector set to ZONE 1:

OR

**When you turn on the Zone 1 sound by pressing ZONE 1 ON/OFF while the receiver is turned on:**

- ➔ The ZONE 1 indicator lights up and the source name for Zone 1 appears on the unit's display, and:
  - If the previously selected **Zone 1 source** is VCR 1, the TV and VCR 1 will turn on automatically.
  - If the previously selected **Zone 1 source** is DVD or DVD MULTI, the TV and DVD player will turn on automatically.
  - If the previously selected **Zone 1 source** is VCR 2, VIDEO, TV or DBS, only the TV will turn on automatically.

- When you turn on the receiver by pressing AUDIO POWER ON on the remote control with the ZONE 1/ZONE 2 selector set to ZONE 2:

OR

**When you turn on the Zone 2 sound by pressing ZONE 2 ON/OFF while the receiver is turned on:**

- ➔ The ZONE 2 indicator lights up on the display, and:
  - If the previously selected **Zone 2 source** is VCR 1, the VCR 1 will turn on automatically.
  - If the previously selected **Zone 2 source** is DVD, the DVD player will turn on automatically.
  - If the previously selected **Zone 2 source** is VCR 2, VIDEO, or DBS, nothing happens.

### **Automatic Power Off (Standby):**

- When you turn off the receiver by pressing  $\odot$ /I STANDBY/ON on the unit or AUDIO POWER STANDBY on the remote control, the TV, VCR 1 and DVD player will turn off (standby).
- When you turn off the Zone 1 sound by pressing ZONE 1 ON/OFF, the selected **Zone 1 source** component and the TV turn off.
  - If the ZONE 2 indicator is lit on the unit's display, nothing happens.
- When you turn off the Zone 2 sound by pressing ZONE 2 ON/OFF, the selected **Zone 2 source** component turns off.
  - If the ZONE 1 indicator is lit on the unit's display, nothing happens.

### **Note:**

*If you turn off the receiver by pressing  $\odot$ /I STANDBY/ON on the unit or AUDIO POWER STANDBY on the remote control, or if you turn off the Zone 1 sound by pressing ZONE 1 ON/OFF while recording on the VCR 1, the VCR 1 will not turn off, but continue recording.*

# Operating JVC's Audio/Video Components

You can operate JVC's audio and video components with this receiver's remote control, since control signals for JVC components are preset in the remote control.

- Refer also to the manuals supplied with your video components.

## Operating Audio Components

### IMPORTANT:

#### To operate JVC's audio components using this remote control:

- You need to connect JVC's audio components through the COMPU LINK (SYNCHRO) jacks (see page 51) in addition to the connections using cables with RCA pin plugs (see pages 10 and 11).
- Aim the remote control directly at the remote sensor on the receiver.
- To operate a source with the remote control, the source must be selected using source selecting buttons on the remote control.
- To operate the cassette deck or MD recorder using the COMPU LINK remote control system, set the source name correctly. (See page 24.)

#### When using the remote control:

- Set the ZONE 1/ZONE 2 selector to **ZONE 1** or **ZONE 2** correctly.
- Check the indication shown on the remote's display when you press a button—this indicates the remote control operation mode together with multi-room operation mode (either for ZONE 1 or ZONE 2) for about two hours.

- The CONTROL button can change the remote control operation mode without changing the source.

Each time you press the button, the remote control operation mode changes in the sequence as follows:

VCR1 → TAPE → CDR → CDDSC → (back to the beginning)

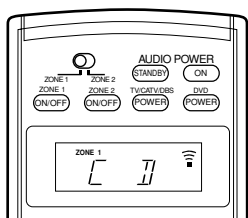
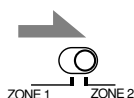
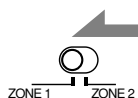

Ex. When you press CD with ZONE 1/ZONE 2 selector set to ZONE 1.

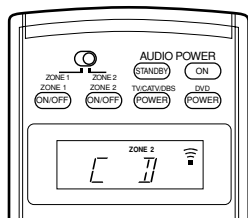

Ex. When you press CD with ZONE 1/ZONE 2 selector set to ZONE 2.

### Tuner



You can always perform the following operations:

- FM : Select the FM band.
- AM : Select the AM band.

After pressing FM or AM, you can perform the following operations:

- 1 – 10, +10 : Select a preset channel number directly.  
For channel number 5, press 5.  
For channel number 15, press +10, then 5.  
For channel number 20, press +10, then 10.

- TUNING UP/DOWN : Tune in to stations.
- FM MODE : Change the FM reception mode.

### Sound control section (Amplifier)

You can always perform the following operations:

- AUDIO POWER ON : Turn on the receiver.
- AUDIO POWER STANDBY : Turn off the receiver.
- ZONE 1 ON/OFF : Turn on or off the Zone 1 sound.
- ZONE 2 ON/OFF : Turn on or off the Zone 2 sound.
- ANALOG/DIGITAL : Switch the analog and digital input alternately.
- BASS BOOST : Turn on or off Bass Boost.
- MIDNIGHT MODE : Select the Midnight Mode.
- EX/ES/PLIIx : Select the EX/ES/PLIIx reproduction mode.
- SURROUND : Turn on and select the Surround modes.
- DSP : Turn on and select the DSP modes.
- SURR/DSP OFF : Turn off the Surround/DSP modes.
- CC CONVERTER : Turn on or off CC Converter.
- ANALOG DIRECT : Turn on or off Analog Direct.
- SLEEP : Set the Sleep Timer.
- DIMMER : Dim or brighten the display.
- MUTING : Turn on or off sound muting.
- VOLUME +/- : Adjust the volume level.

After pressing SOUND, you can perform the following operations:

- TEST : Turn on or off the test tone output.
- FRONT•L then LEVEL +/- : Adjust the left front speaker output level.
- FRONT•R then LEVEL +/- : Adjust the right front speaker output level.
- CENTER then LEVEL +/- : Adjust the center speaker output level.
- SUBWFR then LEVEL +/- : Adjust the subwoofer output level.
- SURR•L then LEVEL +/- : Adjust the left surround speaker output level.
- SURR•R then LEVEL +/- : Adjust the right surround speaker output level.
- SURR BK then LEVEL +/- : Adjust the surround back speaker output level.
- EFFECT : Select the effect level.
- LIVENESS : Select the liveness.

### Notes:

- After adjusting sounds, press the corresponding source selecting button to operate your target source by using the 10 keys; otherwise, the 10 keys cannot be used for operating your target source.
- When you press the FRONT•L, FRONT•R, CENTER, SUBWFR, SURR•L, SURR•R, or SURR BK button, the corresponding speaker name appears on the remote's display.

## CD player



After pressing CD, you can perform the following operations on the CD player:

- PLAY : Start playing.
- ◀◀ : Return to the beginning of the current (or previous) track.
- ▶▶ : Skip to the beginning of the next track.
- STOP : Stop playing.
- PAUSE : Pause playing. To resume, press PLAY.
- 1 – 10, +10 : Select a track number directly.  
For track number 5, press 5.  
For track number 15, press +10, then 5.  
For track number 20, press +10, then 10.  
For track number 30, press +10, +10, then 10.

## CD changer



After selecting “CDDSC” by pressing CONTROL repeatedly, you can perform the following operations on the CD changer:

- PLAY : Start playing.
- ◀◀ : Return to the beginning of the current (or previous) track.
- ▶▶ : Skip to the beginning of the next track.
- STOP : Stop playing.
- PAUSE : Pause playing. To release, press PLAY.
- 1 – 6, 7/P : Select the number of a disc installed in the CD changer.

After pressing CD, you can perform the following operations on the CD changer:

- 1 – 10, +10 : Select a track number directly.  
For track number 5, press 5.  
For track number 15, press +10, then 5.  
For track number 20, press +10, then 10.  
For track number 30, press +10, +10, then 10.

Example:

- Selecting disc number 4, track number 12, and starting playback.
  1. Press CONTROL repeatedly until “CDDSC” appears on the remote’s display, then press 4.
  2. Press CD, then press +10, 2.

If your CD changer is of 200-disc loading capability (except for XL-MC100 and XL-MC301), you can do the following operations using the 10 keys after pressing CD:

1. Select a disc number.
2. Then select a track number (always enter two digits).
3. Press PLAY to start playback.

Examples:

- Selecting disc number 3, track number 2, and starting playback.  
Press 3, then, 0, 2, then PLAY.
- Selecting disc number 10, track number 5, and starting playback.  
Press 1, 0, then, 0, 5, then PLAY.
- Selecting disc number 105, track number 12, and starting playback.  
Press 1, 0, 5, then 1, 2, then PLAY.

### Note:

It is required to press each button within 4 seconds in the above procedures.

## Turntable



After pressing PHONO, you can perform the following operations on the turntable:

- PLAY : Start playing.
- STOP : Stop operations.

## CD recorder



After pressing CDR or selecting “CDR” by pressing CONTROL repeatedly, you can perform the following operations on the CD recorder:

- PLAY : Start playing.
- ◀◀ : Return to the beginning of the current (or previous) track.
- ▶▶ : Skip to the beginning of the next track.
- STOP : Stop playing and recording.
- PAUSE : Pause playing or recording. To resume, press PLAY.
- 1 – 10, +10 : Select a track number directly.  
For track number 5, press 5.  
For track number 15, press +10, then 5.  
For track number 20, press +10, then 10.  
For track number 30, press +10, +10, then 10.
- REC : Press this button together with PLAY to start recording (only for Zone 1 operations).  
Press this button together with PAUSE to enter recording pause (only for Zone 1 operations).

## Cassette deck



After pressing TAPE/MD or selecting “TAPE” by pressing CONTROL repeatedly, you can perform the following operations on the cassette deck:

- PLAY : Start playing.
- REW : Fast-wind the tape from right to left.
- FF : Fast-wind the tape from left to right.
- STOP : Stop playing and recording or fast-wind the tape.
- PAUSE : Pause playing or recording. To resume, press PLAY.
- REC : Press this button together with PLAY to start recording (only for Zone 1 operations).  
Press this button together with PAUSE to enter recording pause (only for Zone 1 operations).

### Note:

When connecting the cassette recorder to the TAPE/MD IN jacks, change the source name correctly (see page 24).

## MD recorder



After pressing TAPE/MD or selecting “TAPE\*” by pressing CONTROL repeatedly, you can perform the following operations on the MD recorder:

- PLAY : Start playing.
- ◀◀ : Return to the beginning of the current (or previous) track.
- ▶▶ : Skip to the beginning of the next track.
- STOP : Stop playing and recording.
- PAUSE : Pause playing or recording. To resume, press PLAY.
- REC : Press this button together with PLAY to start recording (only for Zone 1 operations).  
Press this button together with PAUSE to enter recording pause (only for Zone 1 operations).

### Notes:

- When connecting the MD recorder to the TAPE/MD IN jacks, change the source name correctly (see page 24).
- \* Selecting “TAPE” will allow you to control the MD recorder.

## Operating Video Components

### IMPORTANT:

#### To operate JVC's video components using this remote control:

- You need to connect JVC's video components through the AV COMPU LINK jacks (see page 53) in addition to the connections using cables with RCA pin plugs (see pages 12 and 13).
- Some JVC's VCRs can accept two types of control signals—remote codes "A" and "B." Before using this remote control, make sure that the remote control code of the VCR connected to the VCR 1 IN jacks is set to code "A."
  - When another JVC's VCR is connected to the VCR 2 IN jacks, set its remote control code to code "B." (This remote control cannot emit the control signals of code "B.")
- Aim the remote control directly at the remote sensor on each component, not on the receiver.
- To operate the video component(s) using the RF signals emitted from this remote control, the IR signal transmitter and the RF rod antenna must be connected to this receiver.
  - Place the IR signal transmitter so that it is aimed at the remote sensor(s) on the target video component(s).
  - The RF signal-reachable distance may differ depending on the operating conditions and circumstances.
  - The IR signal transmitter can send signals from a distance of 3 m (10 feet).

#### When using the remote control:

- Set the ZONE 1/ZONE 2 selector to **ZONE 1** or **ZONE 2** correctly.

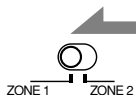

Ex. When you set ZONE 1/  
ZONE 2 selector to ZONE 1.

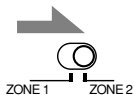

Ex. When you set ZONE 1/  
ZONE 2 selector to ZONE 2.

- Set the TV operation mode selector to **TV** or **CATV/DBS** correctly.

To operate the TV, set it to TV.

- Check the indication shown on the remote's display when you press a button—this indicates the remote control operation mode together with multi-room operation mode (either for ZONE 1 or ZONE 2) for about two hours.
- The CONTROL button can change the remote control operation mode without changing the source. Each time you press the button, the remote control operation mode changes in the sequence as follows:  
VCR1 → TAPE → CDR → CDDSC → (back to the beginning)

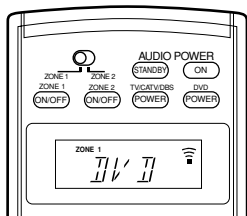
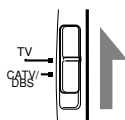

Ex. When you press DVD with  
ZONE 1/ZONE 2 selector  
set to ZONE 1.

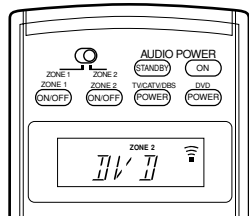

Ex. When you press DVD with  
ZONE 1/ZONE 2 selector  
set to ZONE 2.

### VCR (connected to the VCR 1 jacks)



After pressing VCR 1 or selecting "VCR1" by pressing CONTROL repeatedly, you can perform the following operations on the VCR:

- PLAY** : Start playing.
- REW** : Rewind the tape.
- FF** : Fast-forward the tape.
- STOP** : Stop playing and recording or rewind or fast-forward the tape.
- PAUSE** : Pause playing or recording. To resume, press PLAY.
- REC** : Press this button together with PLAY to start recording (only for Zone 1 operations). Press this button together with PAUSE to enter recording pause (only for Zone 1 operations).
- CHANNEL +/-** : Change the TV channels on the VCR.
- 1 - 9, 10 (RETURN), 0, 100+ (+10)** : Select the TV channels on the VCR. The 10 (RETURN) button will function as ENTER if your VCR requires pressing ENTER after selecting a channel number.

### DVD player



You can always perform the following operations:

- DVD POWER** : Turn on or off the DVD player.

After pressing DVD (or DVD MULTI: only for Zone 1 operations), you can perform the following operations on the DVD player:

- PLAY** : Start playing.
- ◀◀** : Returns to the beginning of the current (or previous) chapter.
- ▶▶** : Skip to the beginning of the next chapter.
- STOP** : Stop playing.
- PAUSE** : Pause playing. To release, press PLAY.
- 1 - 10, 0, +10** : Select a track number directly.
  - For track number 5, press 5.
  - For track number 15, press +10, then 5.
  - For track number 20, press +10, then 10 (or press +10, +10, then 0).
  - For track number 30, press +10, +10, then 10 (or press +10, +10, +10, then 0).

After pressing DVD or DVD MULTI, these buttons can be used for the DVD menu operations.

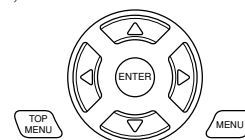

#### Note:

For detailed menu operations, refer to the instructions supplied with the discs or the DVD player.

### TV

You can always perform the following operations (with the TV operation mode selector set to TV):

- TV/CATV/DBS POWER** : Turn on or off the TV.
- TV VOL +/-** : Adjust the volume.
- TV/VIDEO** : Set the input mode (either TV or VIDEO).

After pressing TV/DBS (with the TV operation mode selector set to "TV"), you can perform the following operations on the TV:

- CHANNEL +/-** : Change the channels.
- 1 - 9, 0, 100+ (+10)** : Select the channels.
- RETURN (10)** : Alternates between the previously selected channel and the current channel.

# Operating Other Manufacturers' Equipment

This remote control supplied with the receiver can transmit control signals for other manufacturers' TVs, CATV converters, DBS tuners, VCRs and DVD players.

- Refer also to the manuals supplied with your video components.

## IMPORTANT:

- To operate the other component(s) using the RF signals emitted from this remote control, the IR signal transmitter and the RF rod antenna must be connected to this receiver.
  - Place the IR signal transmitter so that it is aimed at the remote sensor(s) on the target component(s).
  - The RF signal-reachable distance may differ depending on the operating conditions and circumstances.
  - The IR signal transmitter can send signals at a distance of 3 m (10 feet).

### When using the remote control:

- Set the ZONE 1/ZONE 2 selector to **ZONE 1** or **ZONE 2** correctly.

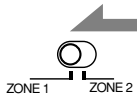

Ex. When you set ZONE 1/  
ZONE 2 selector to ZONE 1.

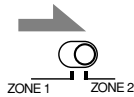

Ex. When you set ZONE 1/  
ZONE 2 selector to ZONE 2.

- Set the TV operation mode selector to **TV** or **CATV/DBS** correctly.

To operate the TV, set it to TV.

To operate the CATV converter or DBS tuner, set it to CATV/DBS.

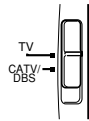

- Check the indication shown on the remote's display when you press a button—this indicates the remote control operation mode together with multi-room operation mode (either for ZONE 1 or ZONE 2) for about two hours.

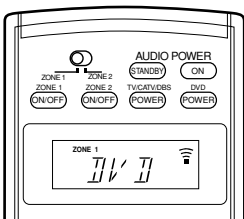

Ex. When you press DVD with  
ZONE 1/ZONE 2 selector  
set to ZONE 1.

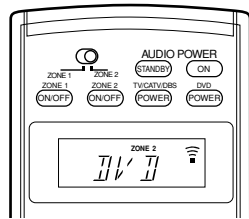

Ex. When you press DVD with  
ZONE 1/ZONE 2 selector  
set to ZONE 2.

## Note:

When replacing the batteries, finish changing them without delay; otherwise, preset manufacturers' codes will be reset.

By changing the transmittable signals from preset ones to the other manufacturers', you can operate the other manufacturer's components using this remote control.

## To change the transmittable signals for operating another manufacturer's TV

1. Set the TV operation mode selector to **TV**.
2. Press and hold **TV/CATV/DBS POWER**.
3. Press **TV/DBS**.
4. Enter a manufacturer's code using buttons **1–9**, and **0**.  
See page 62 to find the code.
5. Release **TV/CATV/DBS POWER**.
6. Try to operate your TV by pressing **TV/CATV/DBS POWER**.

When your TV turns on or off, you have entered the correct code.

If more than one code is listed for your brand of TV, try each one until the correct one is entered.

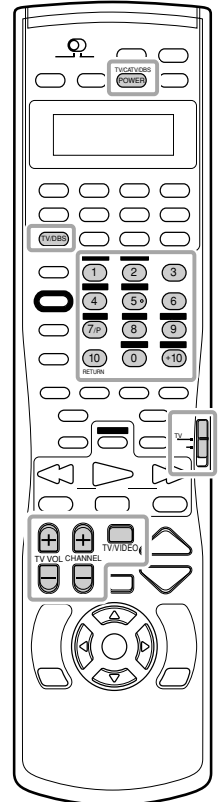

After setting the TV operation mode selector to TV, you can perform the following operations on the TV:

**TV/CATV/DBS POWER**

: Turn on or off the TV.

**TV VOL +/-**

: Adjust the volume.

**TV/VIDEO**

: Set the input mode (either TV or VIDEO).

After pressing TV/DBS (with the TV operation mode selector set to TV), you can perform the following operations on the TV:

**CHANNEL +/-**

: Change the channels.

**1 – 9, 0, 100+ (+10)**

: Select the channels.

**RETURN (10)**

: Alternates between the previously selected channel and the current channel.

## Notes:

- Refer to the manual supplied for the TV.
- Some buttons listed above may not be used for some TVs.
- If you cannot change the channels of some TVs by pressing number buttons, press the CHANNEL +/- buttons.

**To change the transmittable signals for operating another manufacturer's CATV converter or DBS tuner**

1. Set the TV operation mode selector to CATV/DBS.
2. Press and hold TV/CATV/DBS POWER.
3. Press TV/DBS.
4. Enter a manufacturer's code using buttons 1–9, and 0.  
See page 62 to find the code.
5. Release TV/CATV/DBS POWER.
6. Try to operate your CATV converter or DBS tuner by pressing TV/CATV/DBS POWER.

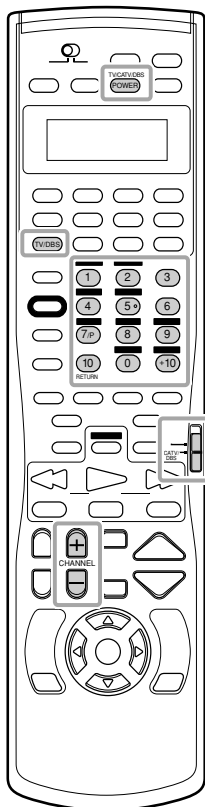

When your CATV converter or DBS tuner turns on or off, you have entered the correct code.

**If more than one code is listed for your brand of CATV converter or DBS tuner, try each one until the correct one is entered.**

**Note:**

You cannot preset the signals for both the CATV converter and DBS tuner at the same time.

After setting the TV operation mode selector to CATV/DBS, you can turn on and off the CATV converter or DBS tuner:

**TV/CATV/DBS POWER:** Turn on or off the CATV converter or DBS tuner.

After pressing TV/DBS (with the TV operation mode selector set to CATV/DBS), you can perform the following operations on the CATV converter or DBS tuner:

- CHANNEL +/- : Change the channels.
- 1 – 9, 0, 100+ (+10) : Select the channels.
- 10 (RETURN) : Function as ENTER if your equipment requires pressing ENTER after selecting a channel number.

**Notes:**

- Refer to the manual supplied for the CATV converter or DBS tuner.
- Some buttons listed above may not be used for some CATV converters or DBS tuners.
- If you cannot change the channels of some CATV converters or DBS tuners by pressing number buttons, press the CHANNEL +/- buttons .

**To change the transmittable signals for operating another manufacturer's VCR**

1. Press and hold DVD POWER.
2. Press VCR 1.
3. Enter a manufacturer's code using buttons 1–9, and 0.  
See page 62 to find the code.
4. Release DVD POWER.
5. Try to operate your VCR 1 by pressing one of the below buttons.

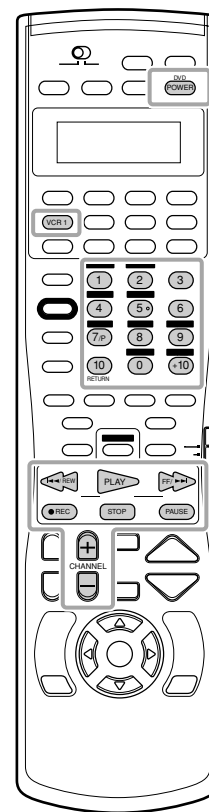

When your VCR 1 have operated correctly, you have entered the correct code.

- DO NOT forget to turn on the VCR 1 before pressing one of the below buttons.

**If more than one code is listed for your brand of VCR, try each one until the correct one is entered.**

After pressing VCR 1, you can perform the following operations on the VCR 1:

- PLAY : Start playing.
- REW : Rewind the tape.
- FF : Fast-forward the tape.
- STOP : Stop playing and recording or rewind or fast-forward the tape.
- PAUSE : Pause playing or recording. To resume, press PLAY.
- REC : Press this button together with PLAY to start recording (only for Zone 1 operations). Press this button together with PAUSE to enter recording pause (only for Zone 1 operations).
- CHANNEL +/- : Change the TV channels on the VCR 1.  
1 – 9, 0, 100+ (+10) : Select the TV channels on the VCR 1.
- 10 (RETURN) : Function as ENTER if your VCR 1 requires pressing ENTER after selecting a channel number.

**Notes:**

- Refer to the manual supplied for the VCR.
- Some buttons listed above may not be used for some VCRs.
- If you cannot change the channels of some VCRs by pressing number buttons, press the CHANNEL +/- buttons .

**To change the transmittable signals for operating another manufacturer's DVD player**

1. Press and hold DVD POWER.
2. Press DVD.
3. Enter a manufacturer's code using buttons 1–9, and 0.  
See page 62 to find the code.
4. Release DVD POWER.
5. Try to operate your DVD player by pressing DVD POWER.

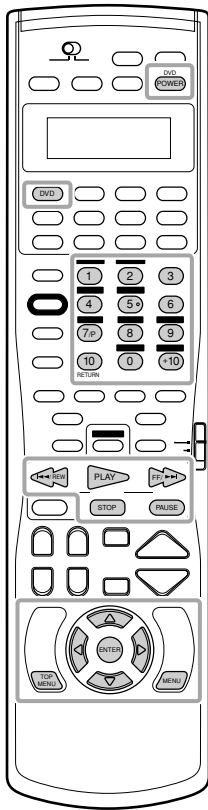

When your DVD player turns on or off, you have entered the correct code.

**If more than one code is listed for your brand of DVD player, try each one until the correct one is entered.**

The following button can be used for operating the DVD player:

**DVD POWER** : Turn on and off the DVD player.

After pressing DVD or DVD MULTI, you can perform the following operations on the DVD player:

- PLAY** : Start playing.
- ⏮** : Return to the beginning of the current (or previous) chapter. Some model of the DVD player, rewind the picture.
- ⏭** : Skip to the beginning of the next chapter. Some model of the DVD player, fast-forward the picture.
- STOP** : Stop playing.
- PAUSE** : Pause playing. To resume, press PLAY.
- 1 – 10, 0, +10** : Select a track number directly.  
For track number 5, press 5.  
For track number 15, press +10, then 5.  
For track number 20, press +10, then 10 (or press +10, +10, then 0).  
For track number 30, press +10, +10, then 10 (or press +10, +10, +10, then 0).

**Notes:**

- Refer to the manual supplied for the DVD player.
- Some buttons listed above may not be used for some DVD players.

After pressing DVD or DVD MULTI, these buttons can be used for the DVD menu operations.

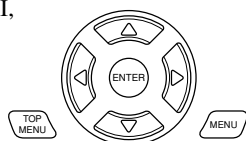

**Note:**

For detailed menu operations, refer to the instructions supplied with the discs or the DVD player.

**To change the transmittable signals for operating another manufacturer's CD player**

1. Press and hold AUDIO POWER ON.
2. Press CD.
3. Enter a manufacturer's code using buttons 1–9, and 0.  
See page 62 to find the code.
4. Release AUDIO POWER ON.
5. Try to operate your CD player by pressing one of the below buttons.

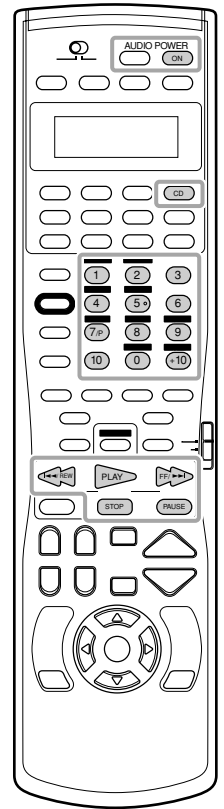

When your CD player operated correctly, you have entered the correct code.

- DO NOT forget to turn on the CD player before pressing one of the below buttons.

**If more than one code is listed for your brand of CD player, try each one until the correct one is entered.**

After pressing CD, you can perform the following operations on the CD player:

- PLAY** : Start playing.
- ⏮** : Return to the beginning of the current (or previous) track.
- ⏭** : Skip to the beginning of the next track.
- STOP** : Stop playing.
- PAUSE** : Pause playing. To resume, press PLAY.
- 1 – 10, +10** : Select a track number directly.  
For track number 5, press 5.  
For track number 15, press +10, then 5.  
For track number 20, press +10, then 10.  
For track number 30, press +10, +10, then 10.

**Notes:**

- Refer to the manual supplied for your CD player.
- Some buttons listed above may not be used for some CD players.

**For TV**

Manufacturer	Codes
JVC	00*, 14, 74
Fisher	05
Sanyo	05
Hitachi	08, 09, 10, 49
Magnavox	08, 17, 49
Mitsubishi	08, 18
RCA/PROSC	08, 24, 29, 30, 31, 48
Samsung	08, 34, 49
Philips	17
Panasonic	24, 26, 76
Toshiba	37, 43
Sharp	38, 77
Sony	39
Zenith	45, 46
Mets	50, 51, 52, 53
Quelle	52, 53, 54, 55, 56, 57, 58, 59, 60, 61, 62, 63, 64, 65, 66, 67

**For CATV converter**

Manufacturer	Codes
Hamlin/Re	01, 02, 03, 04, 05
Jerrold/G	06, 07, 08, 09, 10, 11, 12, 13, 14
Oak	15, 16, 17
Panasonic	18, 19, 20
Pioneer	21, 22
Scientific Atlanta	23, 24, 25
Tocom	26
Zenith	27, 28
General Instrument	29

**For DBS tuner**

Manufacturer	Codes
JVC	56, 57*, 67
Blaupunkt	30
Goldstar	31
Grundig	32, 33
Iltt/Nokia	34
NEC	35, 36
Philips	37, 38
Samsung	39, 40
Siemens	41, 42
Amstrad	43, 44, 45, 46, 47, 48, 49
Hirshmann	48, 52, 53, 54, 55
Orbitech	48
Technisat	48
Echostar	50, 51, 67
Kathrein	52, 58, 59, 60, 61, 62, 63
Schwaiger	61, 64
RCA	65
Sony	66
General Instrument	68

**For VCR**

Manufacturer	Codes
JVC	00*, 26, 27
Aiwa	01
Funai	01
Bell & Howell	03
Fisher	03, 14, 15, 16
Sanyo	03, 48
Magnavox	04, 19, 24
RCA/PROSC	04, 18, 19, 23, 24, 43, 44, 45
Goldstar	07
Emerson	08, 10, 11, 12, 64, 65
GE	18, 19, 20
Hitachi	18, 23, 24
Panasonic	19, 24, 39
Philips	19, 24
NEC	26, 27
Mitsubishi	30, 31, 32, 33
Sharp	37, 50
Toshiba	43, 44
Samsung	45, 61, 62
Sony	52, 53, 54
Zenith	56, 57

**For DVD player**

Manufacturer	Codes
JVC	00*, 02
DENON	01
Panasonic	03
Pioneer	04, 05, 06
RCA	07
Samsung	08
Sony	09
Toshiba	10
Yamaha	11, 12
Philips	13

**For CD player**

Manufacturer	Codes
JVC	00*, 06, 07, 08
DENON	01, 03
Fisher	04
Kenwood	10, 11, 12
Magnavox	15, 16
Marantz	17
Onkyo	18, 20, 21
Panasonic	22, 24
Philips	25, 26, 29
Pioneer	30
RCA	32, 33, 34
Sanyo	35
Sharp	36
Teac	37, 38, 39
Technics	40, 41, 42, 45
Yamaha	46, 47, 48

\* Initial setting

Manufacturers' codes are subject to change without notice. If they are changed, this remote control cannot operate the equipment.



# Troubleshooting

Use this chart to help you solve daily operational problems. If there is any problem you cannot solve, contact your JVC's service center.

	PROBLEM	POSSIBLE CAUSE	SOLUTION
Multi-room operations (Zone 1/Zone 2)	The buttons and controls on the front panel do not work.	The multi-room function is not set correctly.	<ul style="list-style-type: none"> <li>• Press ZONE 1 ON/OFF for Zone 1 operations.</li> <li>• Press ZONE 2 ON/OFF and ZONE 2 CONTROL for Zone 2 operations.</li> </ul>
	No sound from the speakers in Zone 1.	Speaker signal cables are not connected properly.	Check speaker wiring and reconnect if necessary. (See pages 8.)
		The SPEAKERS ON/OFF 1 and SPEAKERS ON/OFF 2/ZONE 2 buttons are not set correctly.	Press SPEAKERS ON/OFF 1 and SPEAKERS ON/OFF 2/ZONE 2 correctly. (See page 21.)
		Incorrect source is selected for Zone 1.	Select the correct source for Zone 1.
		Muting is activated for the Zone 1 source.	Press MUTING to cancel the mute. (See page 24.)
		Incorrect input mode (analog or digital) is selected.	Select the correct input mode (analog or digital). (See page 22.)
	No sound from the front speakers in Zone 2.	Connections are incorrect.	Check connections. For analog connections, see pages 10 to 13. For digital connections, see page 14.
		Speaker signal cables are not connected properly.	Check speaker connection and reconnect if necessary. (See page 16.)
		Zone 1/2 setting for the speakers connected to the FRONT2/ZONE2 SPEAKERS terminals are not set correctly.	Set the Zone 1/2 setting for the speakers correctly to use them as the Zone 2 front speakers. (See page 38.)
		Amplifier connected to the ZONE 2 PREOUT is not turned on.	Turn on the amplifier.
Incorrect source is selected for Zone 2.		Select the correct source for Zone 2.	
Muting is activated for the Zone 2 source.		Press MUTING to cancel the mute. (See page 29.)	
The SPEAKERS ON/OFF 2/ZONE 2 button does not work.	Connections are incorrect.	Make analog connections for Zone 2. For analog connections, see pages 10 to 13.	
	The speakers connected to the FRONT2/ZONE2 SPEAKERS terminals are preset for Zone 1 usage.	Set them for Zone 2 usage. (See page 38.)	
	CD tracks are skipped, tape is rewind, or radio station is changed unintentionally.	When the same source is selected both for Zone 1 and Zone 2, the source in one zone affects the source in the other zone.	This is normal, not a malfunction of the unit. Selecting different sources for Zone 1 and Zone 2 will avoid these troubles.
The receiver does not work correctly as you operate it.	Zone 1 and Zone 2 operations are done at the same time.	If this happens, perform the same operation again.	
“TURN ON ZONE1 OR ZONE2” appears on the display.	The receiver is turned on with the Zone 1 and Zone 2 sounds deactivated.	<ul style="list-style-type: none"> <li>• Press ZONE 1 ON/OFF for Zone 1 operations.</li> <li>• Press ZONE 2 ON/OFF for Zone 2 operations.</li> </ul>	
FM/AM	Continuous hissing or buzzing during FM reception.	Incoming signal is too weak.	Connect an outdoor FM antenna or contact your dealer. (See page 7.)
		The station is too far away.	Select a new station.
		An incorrect antenna is used.	Check with your dealer to be sure you have the correct antenna.
		Antennas are not connected properly.	Check connections. (See page 7.)
	Occasional cracking noise during FM reception.	Ignition noise from automobiles.	Move the antenna farther from automobile traffic.

PROBLEM	POSSIBLE CAUSE	SOLUTION	
Multi-channel reproduction mode cannot be used for Zone 1 sources.	ZONE 2 SPEAKERS are activated.	Deactivate the Zone 2 front speakers.	Surround and DSP modes
Expected surround effect cannot be obtained.	Speakers are deactivated on the Quick Speaker Setup or the Basic Setting.	Activate all connected speakers correctly. (See "Setting the speakers" on page 34.)	
No sound effect such as the Surround mode, DSP mode and equalization pattern.	Analog Direct is turned on.	Turn off Analog Direct. (See page 23.)	
	DVD MULTI is selected as the source (equalization pattern is effective).	Select the source other than DVD MULTI. (See page 20.)	
"DOLBY D EX," "ES DSCRT," or "ES MATRIX" cannot be select as the Surround mode.	Software itself is not Dolby Digital EX or DTS-ES software, or "EX/ES/PLIIX" setting is not correct.	Play back software bearing the mark Dolby Digital EX or DTS-ES and set "EX/ES/PLIIX" setting to "AUTO" or "ON." (See page 45.)	
The display does not light up.	The power cord is not plugged in.	Plug the power cord into an AC outlet.	General
Noise is heard during record playing.	A ground cable of the turntable is not connected to the screw marked (H).	Connect it to the screw marked (H).	
Howling during record playing.	Your turntable is too close to speakers.	Move speakers away from the turntable.	
"NO SUBWFR" appears on the display.	SUBWOOFER OUT ON/OFF is pressed while "SUB WOOFER" is set to "NO."	If subwoofer is connected, set "SUB WOOFER" to "YES" so that SUBWOOFER OUT ON/OFF works.	
"OVERLOAD" starts flashing on the display.	Speakers are overloaded because of high volume either in Zone 1 or in Zone 2.	1. Press $\odot$ /I STANDBY/ON on the front panel to turn off the receiver. 2. Stop the playback source. 3. Turn on the receiver again, and adjust the volume.	
	Speakers are overloaded because of a short circuit of the speaker terminals.	Press $\odot$ /I STANDBY/ON on the front panel to turn off the receiver, then check the speaker wiring. If "OVERLOAD" does not disappear, unplug the AC power cord, then plug it back again. If speaker wiring is not short-circuited, contact your dealer.	
No playback picture of the VCR 1 or DBS tuner can be viewed.	Setting of the component video input are not done for correctly.	Set the component video input setting ("VIDEO IN DBS" and "VIDEO IN VCR1") correctly. (See page 38.)	
DVD MULTI is cannot be select as the source.	ZONE 2 SPEAKERS are activated.	Deactivate the Zone 2 front speakers.	
"DSP NG" starts flashing on the display.	The built-in microcomputer is not functioning correctly.	Press $\odot$ /I STANDBY/ON on the front panel to turn off the receiver. After unplugging the AC power cord, contact your dealer.	
The STANDBY lamp goes off after turning on the power, but soon the receiver turns off again (into standby mode).	Very high voltage or very low voltage is applied to the unit, or built-in power amplifier becomes out of order.	Press $\odot$ /I STANDBY/ON on the front panel to turn off the receiver. After unplugging the AC power cord, consult your dealer.	
Remote control does not work.	The ZONE 1/ZONE 2 selector is not set correctly.	Set the selector correctly either to "ZONE 1" or to "ZONE 2."	
	The TV operation mode selector is not set correctly.	Set the selector correctly either to "TV" or to "CATV/DBS."	
	RF communication between the receiver and the remote control is interrupted from outside.	Consult your dealer.	
	Batteries are weak.	Replace batteries. (See page 15.)	
Remote control does not work properly.	Incorrect remote control operation mode is selected.	Select the correct remote control operation mode. (See pages 56 to 61.)	

# Specifications

## Amplifier

### Output Power

At Stereo Operation

Front Channel: **130 W per channel, min. RMS, driven into 8  $\Omega$ , 20 Hz to 20 kHz, with no more than 0.08% total harmonic distortion.**

At Surround Operation

Front Channel: 130 W per channel, min. RMS, driven into 8  $\Omega$  at 1 kHz, with no more than 0.8% total harmonic distortion.

Center Channel: 130 W, min. RMS, driven into 8  $\Omega$  at 1 kHz, with no more than 0.8% total harmonic distortion.

Surround Channel: 130 W per channel, min. RMS, driven into 8  $\Omega$  at 1 kHz, with no more than 0.8% total harmonic distortion.

Surround Back Channel: 130 W, min. RMS, driven into 8  $\Omega$  at 1 kHz, with no more than 0.8% total harmonic distortion.

## Audio

Audio Input Sensitivity/Impedance (1 kHz)

DVD IN, VCR 1 IN, VCR 2 IN, TV SOUND/DBS IN, VIDEO: 200 mV/47 k $\Omega$   
TAPE/MD IN, CDR IN, CD IN: 200 mV/47 k $\Omega$   
PHONO IN (MM): 2.5 mV/47 k $\Omega$

Audio Input (DIGITAL IN)\*

Coaxial DIGITAL 1 (DVD): 0.5 V(p-p)/75  $\Omega$   
Optical DIGITAL 2 (CD), DIGITAL 3 (TV), DIGITAL 4 (CDR): -21 dBm to -15 dBm (660 nm  $\pm$ 30 nm)

\* Corresponding to Linear PCM, Dolby Digital, and DTS (with sampling frequency—32 kHz, 44.1 kHz, 48 kHz).

Audio Output Level

ZONE 2 PREOUT: 1 V  
PREOUT: 1 V

Recording Output Level

TAPE/MD OUT, CDR OUT, VCR 1 OUT, VCR 2 OUT: 200 mV

Digital Output (DIGITAL OUT)

Optical Signal wave length: 660 nm  
Output level: -21 dBm to -15 dBm

Signal-to-Noise Ratio ('66 IHF/'78 IHF)

DVD IN, VCR 1 IN, VCR 2 IN, TV SOUND/DBS IN, VIDEO: 87 dB/80 dB  
TAPE/MD IN, CDR IN, CD IN: 87 dB/80 dB  
PHONO IN (MM): 70 dB/78 dB at OUT (REC)

Frequency Response (8  $\Omega$ )

DVD IN, VCR 1 IN, VCR 2 IN, TV SOUND/DBS IN, VIDEO: 20 Hz to 100 kHz (+1 dB, -3 dB)

TAPE/MD IN, CDR IN, CD IN: 20 Hz to 100 kHz (+1 dB, -3 dB)

PHONO IN (MM): 20 Hz to 20 kHz ( $\pm$ 1 dB)

RIAA Phono Equalization:  $\pm$ 1.0 dB (20 Hz to 20 kHz)

Bass Boost: +6 dB  $\pm$ 1.0 dB at 100 Hz

Equalization:

63 Hz, 250 Hz, 1 kHz, 4 kHz, 16 kHz:  $\pm$ 8 dB (in 2 dB steps)

## Video

Video Input Sensitivity/Impedance

Composite Video

DVD IN, TV SOUND/DBS IN, VCR 1 IN, VCR 2 IN, VIDEO: 1 V(p-p)/75  $\Omega$

S-video

DVD IN, TV SOUND/DBS IN, VCR 1 IN, VCR 2 IN, VIDEO

(Y: luminance): 1 V(p-p)/75  $\Omega$

(C: chrominance, burst): 0.286 V(p-p)/75  $\Omega$

Component Video DVD IN, DBS (VCR 1) IN

(Y: luminance): 1 V(p-p)/75  $\Omega$

(Pb/Pr): 0.7 V(p-p)/75  $\Omega$

Video Output Level

Composite Video

VCR 1 OUT, VCR 2 OUT, MONITOR OUT: 1 V(p-p)/75  $\Omega$

S-video

VCR 1 OUT, VCR 2 OUT, MONITOR OUT

(Y: luminance): 1 V(p-p)/75  $\Omega$

(C: chrominance, burst): 0.286 V(p-p)/75  $\Omega$

Component Video MONITOR OUT

(Y: luminance): 1 V(p-p)/75  $\Omega$

(Pb/Pr): 0.7 V(p-p)/75  $\Omega$

Synchronization:

Negative

Signal-to-Noise Ratio:

45 dB

## FM tuner (IHF)

Tuning Range: 87.5 MHz to 108.0 MHz

Usable Sensitivity Monaural: 12.8 dBf (1.2  $\mu$ V/75  $\Omega$ )

50 dB Quieting Sensitivity Monaural: 16.0 dBf (1.7  $\mu$ V/75  $\Omega$ )

Stereo: 37.5 dBf (20.5  $\mu$ V/75  $\Omega$ )

Stereo Separation at OUT (REC): 35 dB at 1 kHz

## AM tuner

Tuning Range: 530 kHz to 1 710 kHz

## General

Power Requirements: AC 120 V $\sim$ , 60 Hz

Power Consumption: 320 W/440 VA (at operation)

2 W (in standby mode)

Dimensions (W x H x D): 435 mm x 157 mm x 425 mm

(17 <sup>3</sup>/<sub>16</sub> in. x 6 <sup>3</sup>/<sub>16</sub> in. x 16 <sup>3</sup>/<sub>4</sub> in.)

Mass: 12.0 kg (26.5 lbs)

Designs & specifications are subject to change without notice.



# LIMITED WARRANTY

AUDIO-2

JVC COMPANY OF AMERICA warrants this product and all parts thereof, except as set forth below ONLY TO THE ORIGINAL PURCHASER AT RETAIL to be FREE FROM DEFECTIVE MATERIALS AND WORKMANSHIP from the date of original retail purchase for the period as shown below. ("The Warranty Period")

PARTS	<b>2 YRS</b>	LABOR	<b>2 YRS</b>
-------	--------------	-------	--------------

THIS LIMITED WARRANTY IS VALID ONLY IN THE FIFTY (50) UNITED STATES, THE DISTRICT OF COLUMBIA AND IN COMMONWEALTH OF PUERTO RICO.

**WHAT WE WILL DO:**

If this product is found to be defective, JVC will repair or replace defective parts at no charge to the original owner. Such repair and replacement services shall be rendered by JVC during normal business hours at JVC authorized service centers. Parts used for replacement are warranted only for the remainder of the Warranty Period. All products and parts thereof may be brought to a JVC authorized service center on a carry-in basis except for Television sets having a screen size 25 inches and above which are covered on an in-home basis.

**WHAT YOU MUST DO FOR WARRANTY SERVICE:**

Return your product to a JVC authorized service center with a copy of your bill of sale. For your nearest JVC authorized service center, please call toll free: (800) 537-5722.

If service is not available locally, box the product carefully, preferably in the original carton, and ship, insured, with a copy of your bill of sale plus a letter of explanation of the problem to the nearest JVC Factory Service Center, the name and location of which will be given to you by the toll-free number.

If you have any questions concerning your JVC Product, please contact our Customer Relations Department.

**WHAT IS NOT COVERED:**

This limited warranty provided by JVC does not cover:

1. Products which have been subject to abuse, accident, alteration, modification, tampering, negligence, misuse, faulty installation, lack of reasonable care, or if repaired or serviced by anyone other than a service facility authorized by JVC to render such service, or if affixed to any attachment not provided with the products, or if the model number or serial number has been altered, tampered with, defaced or removed;
2. Initial installation and installation and removal for repair;
3. Operational adjustments covered in the Owner's Manual, normal maintenance, video and audio head cleaning;
4. Damage that occurs in shipment, due to act of God, and cosmetic damage;
5. Signal reception problems and failures due to line power surge;
6. Video Pick-up Tubes/CCD Image Sensor, Cartridge, Stylus (Needle) are covered for 90 days from the date of purchase;
7. Batteries (except that Rechargeable Batteries are covered for 90 days from the date of purchase);

There are no express warranties except as listed above.

THE DURATION OF ANY IMPLIED WARRANTIES, INCLUDING THE IMPLIED WARRANTY OF MERCHANTABILITY, IS LIMITED TO THE DURATION OF THE EXPRESS WARRANTY HEREIN.

JVC SHALL NOT BE LIABLE FOR THE LOSS OF USE OF THE PRODUCT, INCONVENIENCE, LOSS OR ANY OTHER DAMAGES, WHETHER DIRECT, INCIDENTAL OR CONSEQUENTIAL (INCLUDING, WITHOUT LIMITATION, DAMAGE TO TAPES, RECORDS OR DISCS) RESULTING FROM THE USE OF THIS PRODUCT, OR ARISING OUT OF ANY BREACH OF THIS WARRANTY. ALL EXPRESS AND IMPLIED WARRANTIES, INCLUDING THE WARRANTIES OF MERCHANTABILITY AND FITNESS FOR PARTICULAR PURPOSE, ARE LIMITED TO THE WARRANTY PERIOD SET FORTH ABOVE.

Some states do not allow the exclusion of incidental or consequential damages or limitations on how long an implied warranty lasts, so these limitations or exclusions may not apply to you. This warranty gives you specific legal rights and you may also have other rights which vary from state to state.

JVC COMPANY OF AMERICA  
DIVISION OF JVC AMERICAS CORP.

1700 Valley Road  
Wayne, NJ 07470

REFURBISHED PRODUCTS CARRY A SEPARATE WARRANTY, THIS WARRANTY DOES NOT APPLY. FOR DETAILS OF REFURBISHED PRODUCT WARRANTY, PLEASE REFER TO THE REFURBISHED PRODUCT WARRANTY INFORMATION PACKAGED WITH EACH REFURBISHED PRODUCT.

**For customer use:**

Enter below the Model No. which is located either on the rear, bottom or side of the cabinet. Retain this information for future reference.

Model No. : \_\_\_\_\_

Serial No. : \_\_\_\_\_

Purchase data : \_\_\_\_\_

Name of dealer : \_\_\_\_\_

# Authorized Service Centers

---

QUALITY **JVC**<sup>®</sup> SERVICE  
*HOW TO LOCATE YOUR JVC SERVICE CENTER*  
**TOLL FREE: 1 (800) 537-5722**  
**<http://www.jvc.com>**

Dear Customer,

In order to receive the most satisfaction from your purchase, please read the instruction booklet before operating the unit. In the event that repairs are necessary, please call 1 (800)537-5722 for your nearest authorized servicer or visit our website at **[www.JVC.com](http://www.JVC.com)**. Remember to retain your Bill of Sale for Warranty Service.

---

## **Do not service the television yourself**

---

### **Caution**

To prevent electrical shock, do not open the cabinet. There are no user serviceable parts inside. Please refer to qualified service personnel for repairs.

### **Accessories**

To purchase accessories for your JVC product, please call toll free: 1 (800)882-2345 or on the web at **[www.JVC.com](http://www.JVC.com)**

---

